



Nomad Lock-Up Kit Installation Instructions

Suitable for:



Toyota Hilux 8th Gen with AC60 6 Speed Auto

WITH THE FOLLOWING ENGINES:
1GD-FTV 2.8L Turbo Diesel (07/2015 to Present)

Please read through all of the instructions carefully before proceeding. If any of the information does not appear correct or the diagrams don't match your vehicle, please contact Wholesale Automatic Transmissions or your place of purchase.

Table of Contents

1. Parts List	3
2. Information to note prior to starting	4
2.1. Electrical Safety.....	4
2.2. Identifying the Nomad Lock-Up Kit Parts.....	5
3. Installing the Nomad Lock-Up Kit	7
3.1. Recommended Mounting Location	7
3.2. Installing the Harness in the Cabin	8
3.3. OEM ECU Wiring behind Glove Box.....	19
3.4. ECU Wiring Diagram for approx. Jun 2015 to Aug 2020	20
3.5. ECU Wiring Diagram for approx. Sept 2020 onwards	23
3.6. Final tidy up	26
3.7. Lock-Up Module Bypass.....	27
4. Downloading the Nomad Lock-Up App	28
4.1. Installing Nomad Lock-Up App onto Apple Devices.....	28
4.2. Troubleshooting Installation on Apple Devices.....	30
4.3. Installing Nomad Lock-Up App onto Android Devices	32
4.4. Troubleshooting Installation on Android Devices	35
5. Setup Wizard	37
5.1. First Connection and Firmware Update	37
5.2. Vehicle Configuration.....	39

1. Parts List

Nomad Lock-Up
ModuleNomad Lock-Up
Main HarnessHilux OEM Style
Momentary Switch

OEM Switch Loom



Resistor Loom - 6D

Hilux CAN Bus Interface
Loom + optional connectorModule Bypass
Connector2 x Long Metal Self
Tapping Screws2 x Short Metal Self
Tapping Screws4 x 30mm Pieces of
Black Heatshrink

10 x Cable Ties

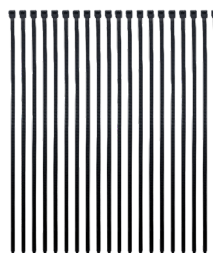

Getting Started Guide



Estimated Install Time: 2 Hours

2. Information to note prior to starting

2.1. Electrical Safety

- 2.1.1 Disconnect all vehicle power sources including batteries, chargers and solar systems before starting the installation process.
- 2.1.2 The Load Resistor **MUST** be mounted to a metal surface clear of carpet, plastic or any material that could melt. This resistor can reach temperatures over 50°C when in operation.



- 2.1.3 You can mount the Module anywhere inside or outside of the vehicle. The Module is IP68 rated, so it can be mounted in the engine bay, however it must be away from heat sources such as turbos, exhausts and the engine block. Also take into consideration, the further away from the driver, the lower the Bluetooth signal strength will be. We recommend mounting the module inside that cabin.



- 2.1.4 The installation of this kit requires the fitter to have good knowledge of 12 volt wiring, an understanding of wiring schematics and good experience with soldering wires together. If you don't feel comfortable doing any of these tasks, then please contact one of our local Authorised Fitting Agents or your local Auto Electrician to have the unit installed professionally.

2.2. Identifying the Nomad Lock-Up Kit Parts

- 2.2.1 There are four (4) legs on the Nomad Lock-Up Harness (TCLU-HARNESS) that you need to be aware of. These legs define the purpose of the wires contained within.

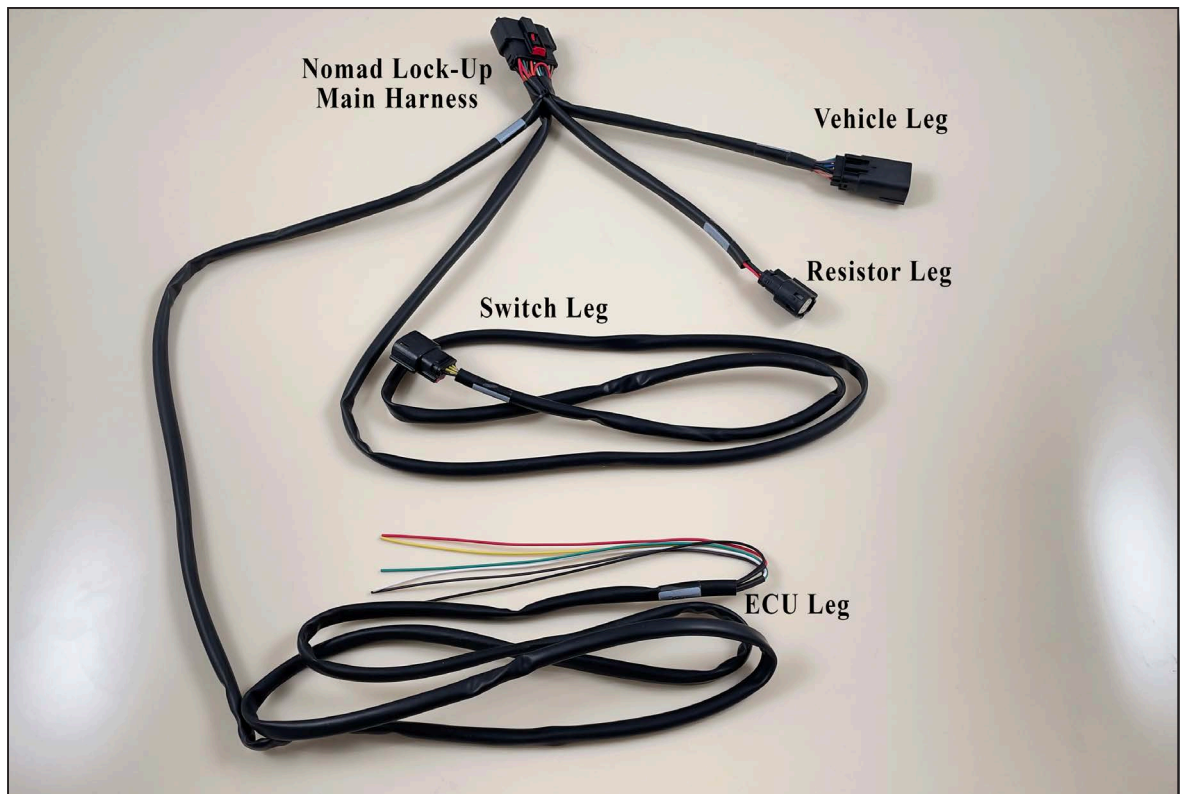

2.2.2 ECU Leg

This leg contains the wires that will be wired into the OEM Transmission TCU. These wires connect to the Lock-Up Solenoid inside the transmission as well as picking up 12v+ Switched Power and Ground. If you feel there is too much wire on the ECU leg, this can be trimmed back to a more suitable length. Just be conservative with your trimming as extending the wires is not recommended.



2.2.3 Switch Leg

This leg runs to where ever you plan to install the manual lock-up switch. This may use either a OEM style push switch or a Carling style rocker switch, depending on your vehicles dash configuration.

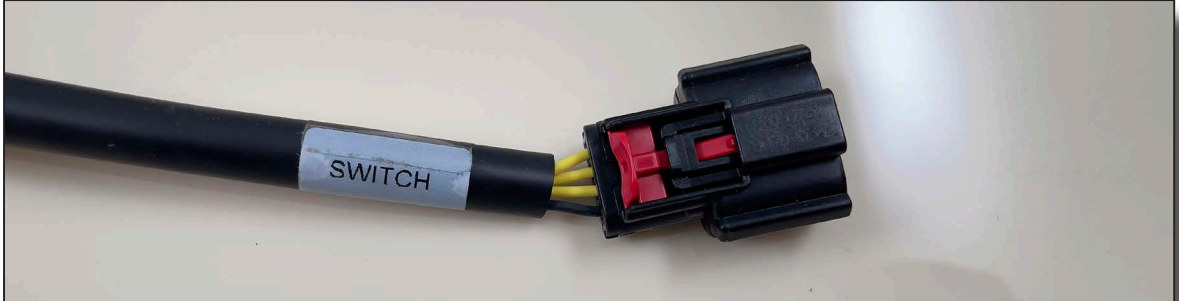

2.2.4 Resistor Leg

The resistor leg is one of the smaller legs that provide a universal connection to the load resistor. This load resistor will vary depending on the transmission the Nomad Lock-Up Kit is controlling.



2.2.5 Vehicle Leg

Lastly the vehicle leg, this leg is for the wires that will connect to various signals in the vehicle depending on the vehicle you are installing the Nomad Lock-Up kit into. This may include TPS (Throttle Position Sensors), VSS (Vehicle Speed Sensors), or the vehicles internal CAN Bus.

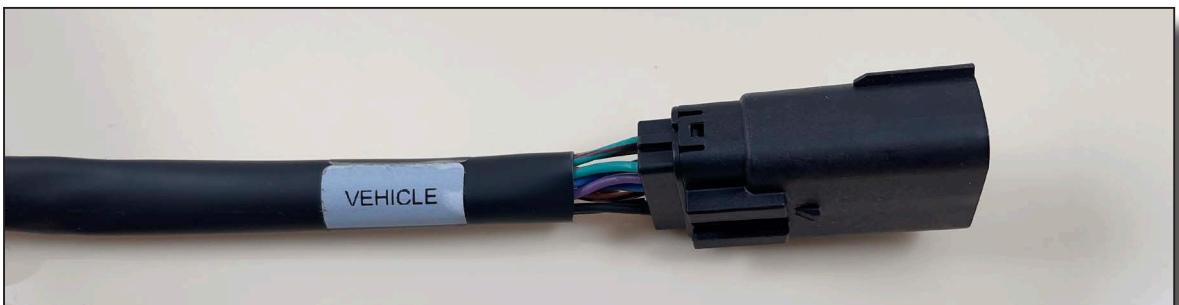

3. Installing the Nomad Lock-Up Kit

3.1. Recommended Mounting Location

- 3.1.1 While you are free to mount the various parts of the Nomad Lock-Up kit any where in your vehicle that you feel is most appropriate, the installation instructions will assume you are mounting the parts in our recommended locations.

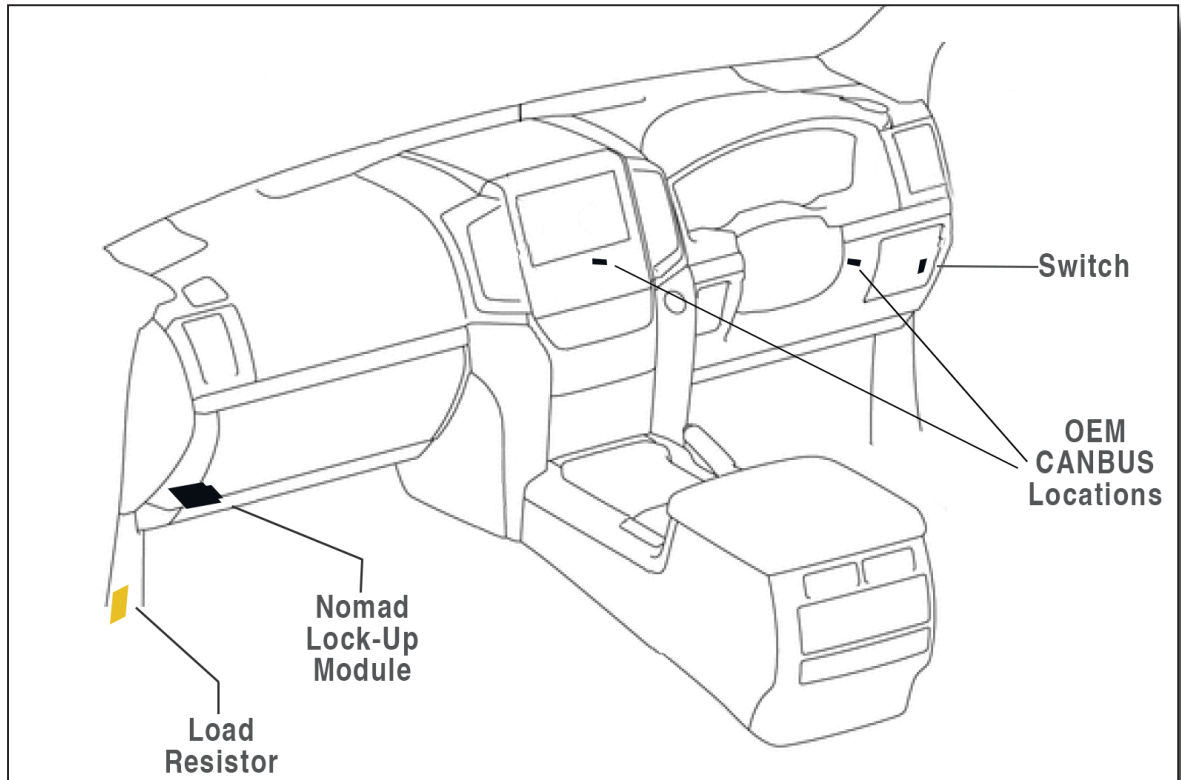

3.2. Installing the Harness in the Cabin

****Disconnect all vehicle power sources including batteries, chargers and solar systems before starting the installation process.****

The resistor is used to dissipate heat/power from the OEM TCU. As such, the resistor will get extremely hot when the Nomad Lock-Up system is operating.

The resistor **MUST** be mounted to a flat, metal surface to aid in heat dissipation and because mounting to anything other than metal may cause that surface to melt due to the heat.

For the Toyota Hilux, we have found a good location for the Load Resistor is on the passenger footwell outer wall. Then for the Module to be mounted behind or just above the footwell cover. Ultimately, this decision will be up to the installer as we are not able to account for accessories or slight variations in your model.

- 3.2.1 Start removing the glovebox by twisting and removing the locking tabs at the top of the glovebox. Also disconnect the air ram from the side of the glovebox at the same time. Then pull rearwards on the glovebox to remove the glovebox.



- 3.2.2 Remove the passenger lower sill panel, the sill panel levers up on the carpet side. Then remove the outer footwell cover by first removing the plastic nut that is up against the firewall. Then lever the rear side of the cover towards the transmission tunnel to unclip.

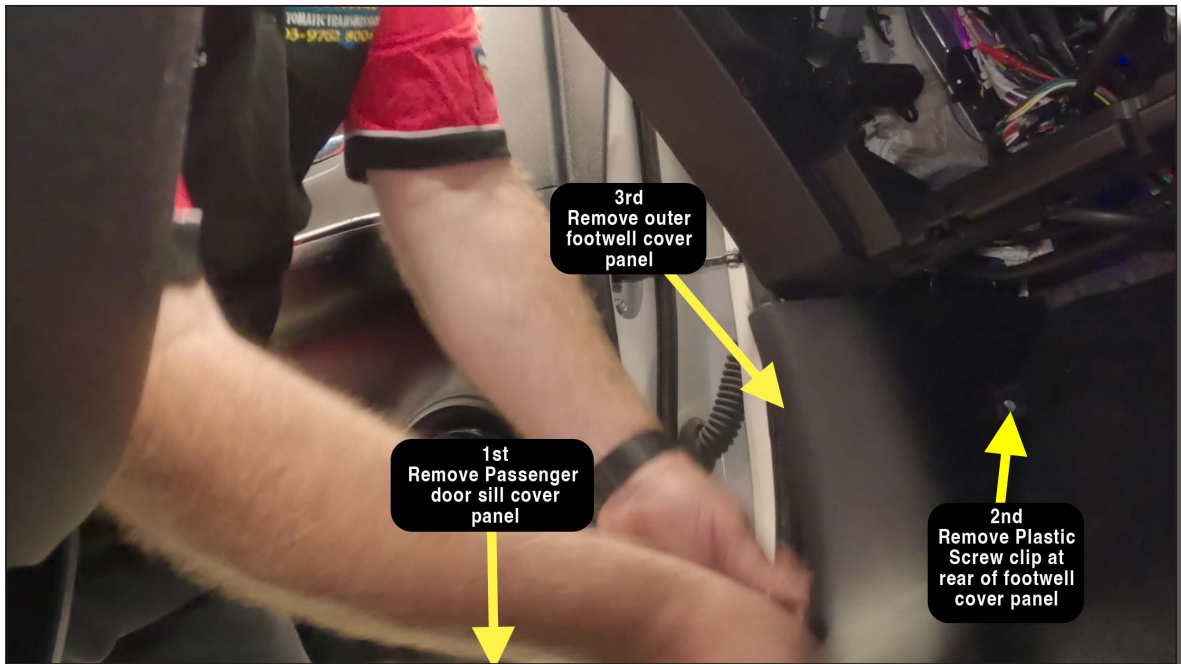

3.2.3 We generally recommend mounting the load resistor on the outer passenger footwell wall. However, there is no specific place it needs to be mounted, so if your vehicle has no space here, feel free to find some flat metal elsewhere in your vehicle. Just bear in mind the cabling needs to reach to where you mount the main module, must be a metal surface, and must not allow any plastic or wires to come in contact with the load resistor as it will get hot.

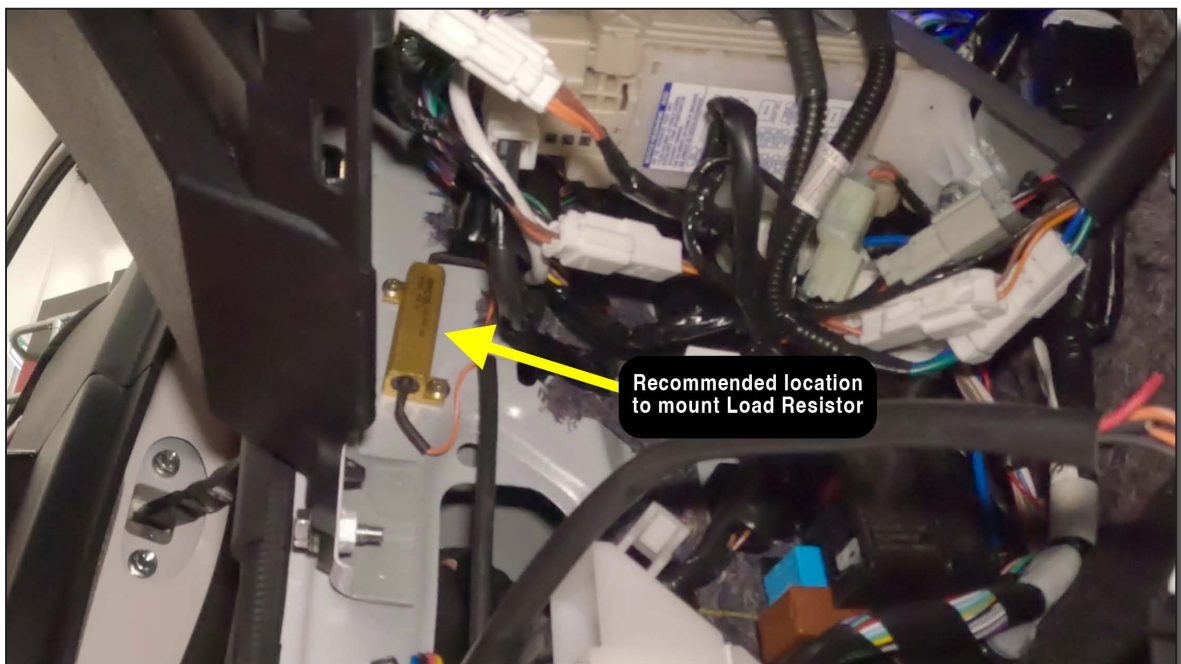

- 3.2.4 Hold the resistor in place on the outer passenger footwell wall so that you can access one of the mounting holes on the resistor. Using a 3mm drill bit, drill a pilot hole through one of the mounting flange holes and into the metal surface.
- 3.2.5 Use one(1) of the supplied 15mm metal self tapping screws to secure the load resistor in place. Don't fully tighten yet.
- 3.2.6 Use the 3mm drill bit and drill a pilot hole through the other mounting flange hole in the load resistor and the surface.
- 3.2.7 Use one (1) of the supplied 15mm metal self tapping screws to secure the load resistor in place. Tighten both screws.
- 3.2.8 Prior to mounting the Lock-Up Module, we find it easier to feed the CANBUS and Switch wiring across to the drivers side.
- 3.2.9 Remove the Air Con panel by pulling rearwards on the panel. This will give you access to feed the wiring across to the drivers side of the vehicle. You may also need to remove some dash panels on the drivers side, so you can gain access to the switch panel and CANBUS connections. *Note - You may need to get access behind the radio, leave this panel out for the moment.



- 3.2.10 To remove the switch panel from the drivers side, use a plastic trim panel tool to lever the top of the panel out. You may find it helpful to reach up under the dash and push on the rear of the switch panel.
- 3.2.11 Feed the CANBUS terminals and the switch connector from the passenger footwell area, up behind the Air Con panel and then across to the switch panel area. Taking care while routing to be able to cable tie the looms so they won't interfere with any moving part or re-fitting of panel.

3.2.12 There are three different CANBUS connections depending on which Toyota Factory built your vehicle. Unfortunately we have not uncovered a definitive way to know which one is which from the VIN. You will need to look behind the switch panel first to identify which CAN connector you have. If you don't have either connector then you will most likely have the third option.

3.2.12.1 **TSAM - Toyota South Africa Motors**

TSAM use a 22 pin connector that needs our wires to be inserted directly into the connector

3.2.12.2 **AVA - Associated Vehicle Assemblers**

AVA use a junction box for the 2 pin connector we supplied.

3.2.12.3 **TMT - Toyota Motor Thailand**

This model doesn't have either connector behind the switch, instead it has a connector located beside the radio/entertainment system in the space between the radio and the dash cluster.

3.2.13 **Toyota South Africa Motors (TSAM) version**

3.2.13.1 The TSAM version used a dual row multi-pin connector for the CAN junction.

3.2.13.2 Locate the OEM CANBUS Connector and termination receptacle behind the switch panel. You need to remove this connector to add our wires to the CANBUS.

PLEASE ENSURE YOUR BATTERIES ARE DISCONNECTED BEFORE REMOVING THIS CONNECTOR

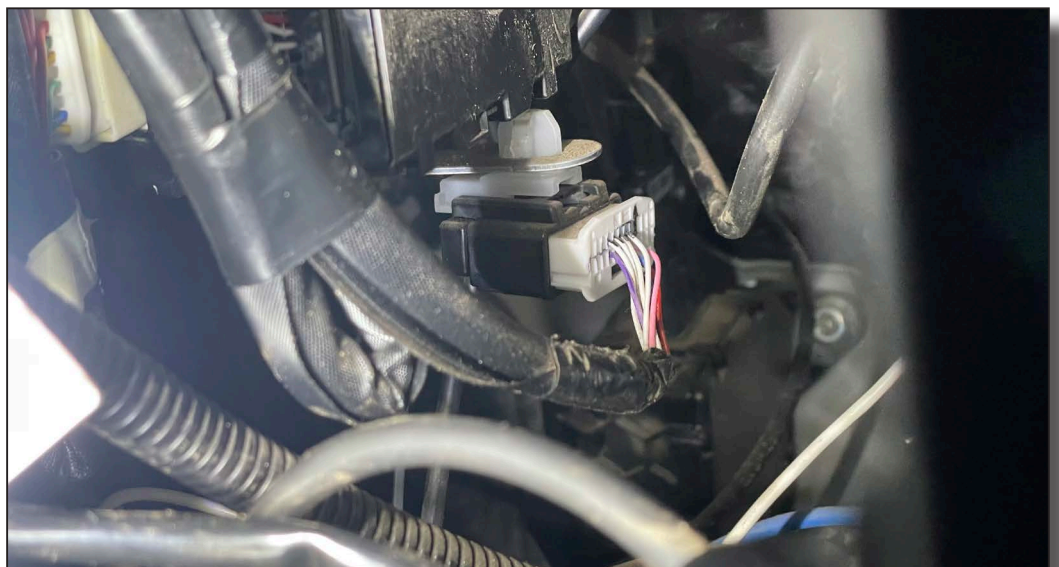

- 3.2.13.3 Remove the connector from the black receptacle by using a small screwdriver or pick to release the locking tab.

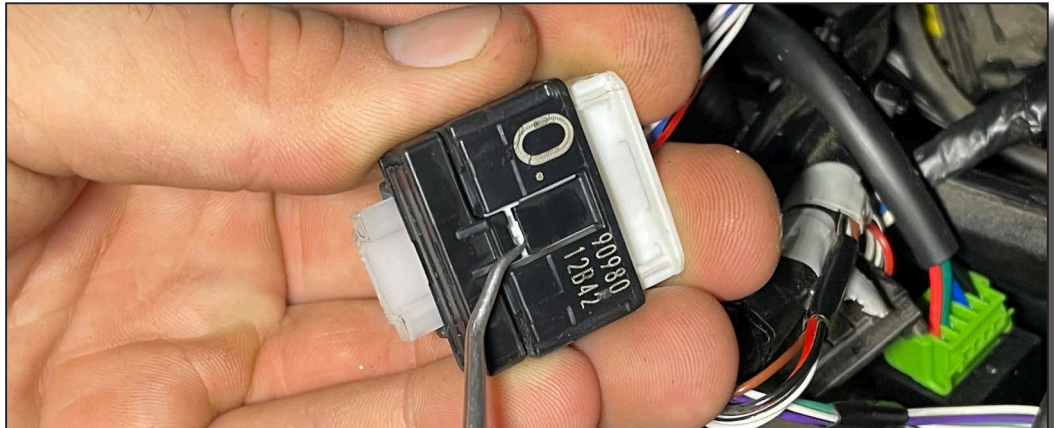

- 3.2.13.4 Turn the connector over to show the TPA (Terminal Position Assurance). Unlock the TPA to allow addition of new terminals to the connector, using a small flat blade screw driver or pick. The only moves approx 1mm.



- 3.2.13.5 Insert the new terminals with the locating tab aligned with the locating slot on the connector. The wires can be inserted into any pair of terminal locations that are vertically aligned (directly above and below each other).

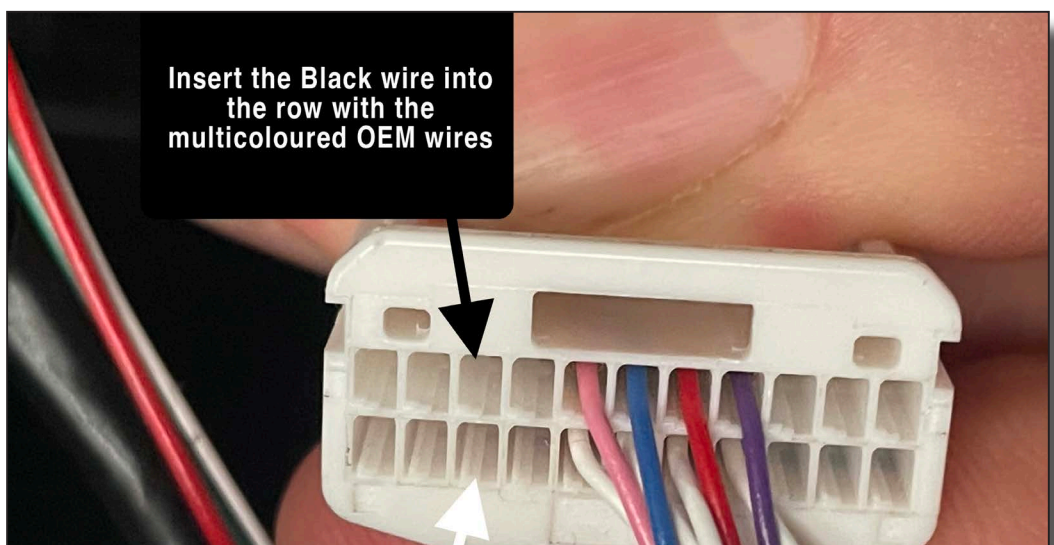

- 3.2.13.6 It is **CRITICAL** that the correct colour wire goes to the correct row in the connector. CAN has a polarity and if reversed, could cause communication errors in the vehicle.
Black Wire must insert into the row beside the OEM multicolour wires.
White Wire must insert into the Bottom row - beside the OEM white wires.
Push both wires in until you feel a slight click.



- 3.2.13.7 Push the TPA in so it is flush with the connector, locking the terminals in place. If you find it has resistance, don't force it. Most likely your terminals are not fully inserted into the connector.
- 3.2.13.8 Re-install the CAN Connector into its receptacle and remount in it's original location.

3.2.14 Associated Vehicle Assemblers (AVA) version

- 3.2.14.1 The AVA version uses a junction box housing that accepts 2 pin connectors. Remove the junction box by squeezing the plastic retainer that holds the junction box to its mount. This will allow you to bring the junction box out of switch panel hole.
- 3.2.14.2 You will need to insert the CANBUS terminals into the supplied 2 pin connector.

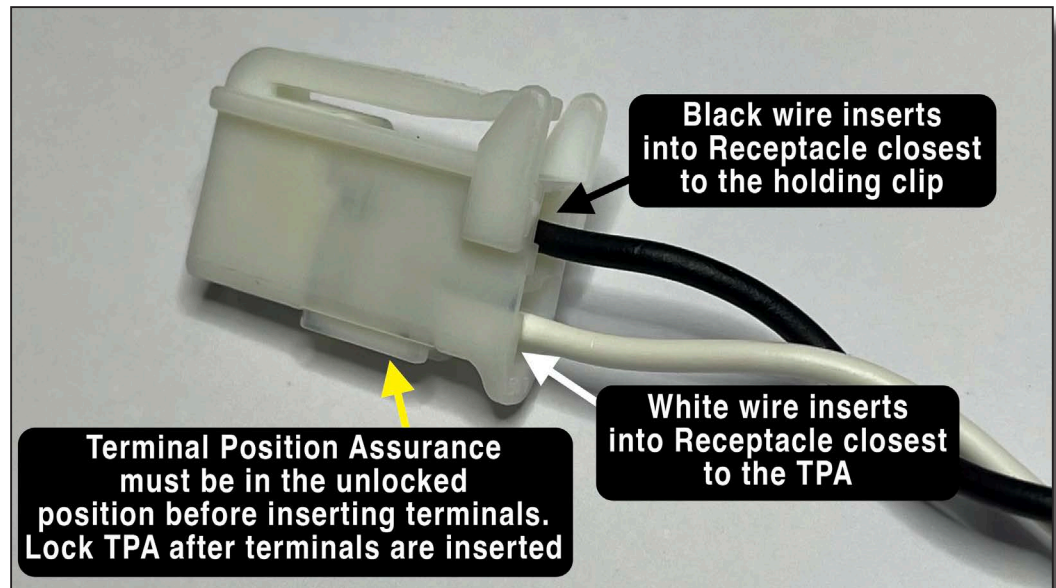

- 3.2.14.3 Using a small flat blade screw driver, extract the TPA (Terminal Position Assurance) by approx 1mm.
- 3.2.14.4 Insert the Black wire from the CANBUS loom into the top terminal position closest to the clip. Align the tab on the terminal with the tab opening on the Connector. You will feel a small click when fully inserted.
- 3.2.14.5 Insert the White wire from the CANBUS loom into the bottom terminal position furthest from the clip. Align the tab on the terminal with the tab opening on the Connector. You will feel a small click when fully inserted.
- 3.2.14.6 Push the TPA into the connector to re-engage. If the TPA won't push in easily, it may mean the terminals are not fully inserted correctly.

- 3.2.14.7 With the TPA re-engaged, insert the connector into one of the free receptacles in the Junction Connector.

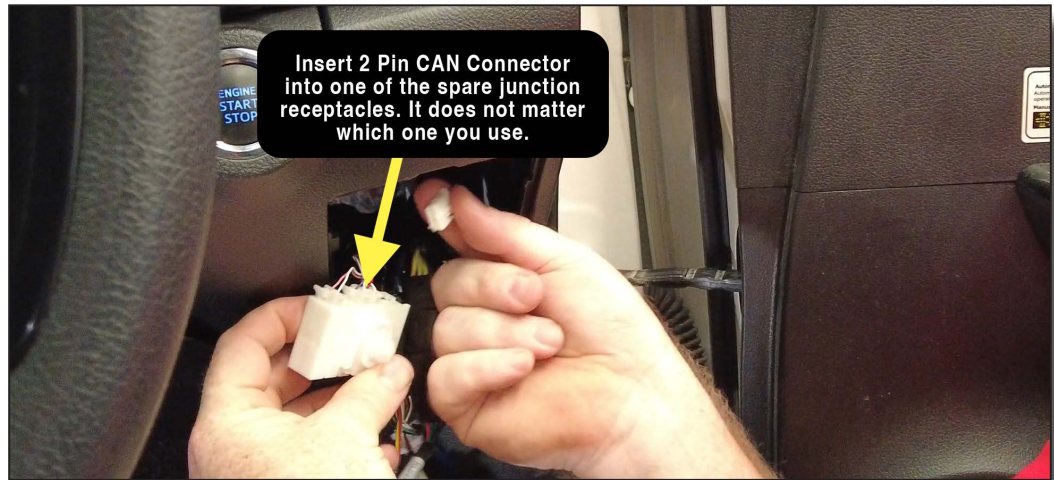

3.2.15

3.2.16 Toyota Motor Thailand (TMT) version



- 3.2.16.1 These earlier models did not have a CAN connector located behind the switch panel. For these models you will need to get access behind the radio/entertainment system. Here is a link and QR code to a video on YouTube that will show you how to remove the radio. We have also listed the steps below.

<https://www.youtube.com/watch?v=ZgxEWUGTk7c>

- 3.2.16.2 Remove the 2x Plastic clips holding the top of the dash cluster surround using a stumpy phillips head screw driver. You don't need to fully remove this cover, just lever out the side closest to the radio.
- 3.2.16.3 Remove the trim running across the top of the radio all the way to the passenger door.
- 3.2.16.4 Remove the upper glove box by pulling from the top of the upper glove box in the opening left by the trim panel removed in previous step.
- 3.2.16.5 Remove the Air Con panel below the radio (if you haven't already)
- 3.2.16.6 Remove the 4x bolts holding the radio in place. 2x above and 2x below.
- 3.2.16.7 Carefully remove the radio while disconnecting any wires that are tight.
- 3.2.16.8 Locate the CAN Connector behind the radio on the dash cluster side.

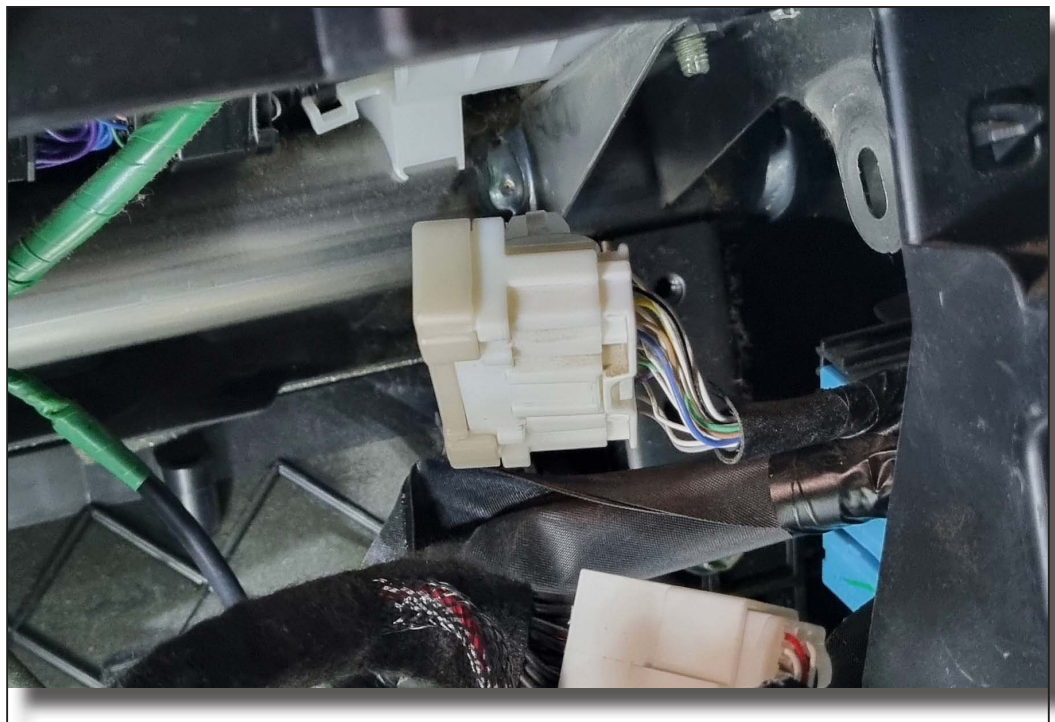

- 3.2.16.9 Turn the connector over to show the TPA (Terminal Position Assurance). Unlock the TPA to allow addition of new terminals to the connector, using a small flat blade screw driver. The TPA only needs to move approx 1mm.

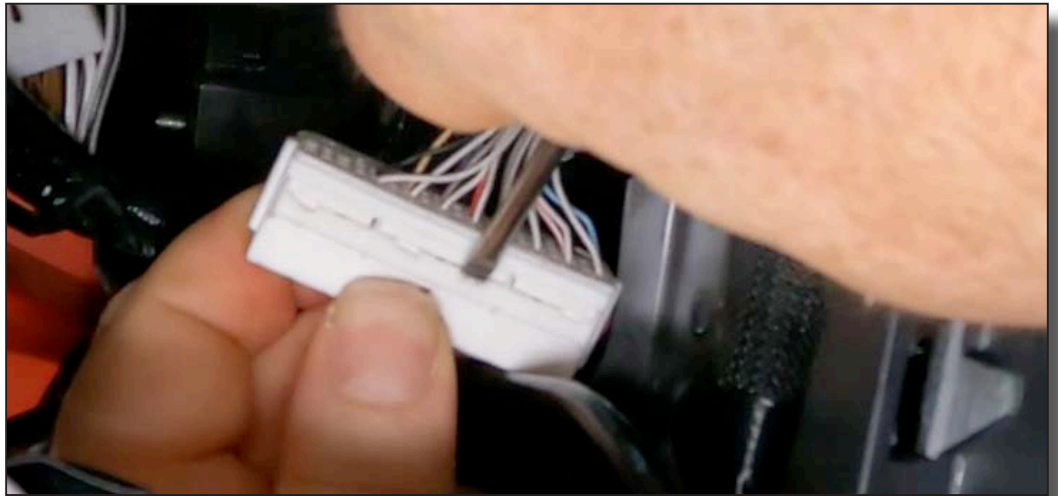

- 3.2.16.10 Insert the terminals with the cutouts in the terminal facing the TPA side of the connector. Location of the correct wires in the correct row is VITAL.

Black Wire with terminal into Pin 9 (Top row - closest to locking clip)
White Wire with terminal into Pin 19 (Bottom row - away from clip)
Push both wires it until you feel a click.

If Pins 9 and 19 already have wires in them, you can move to any of the terminal pairs ie 10 and 20 or 6 and 16, just make sure Black in on the top row and White is on the bottom row.

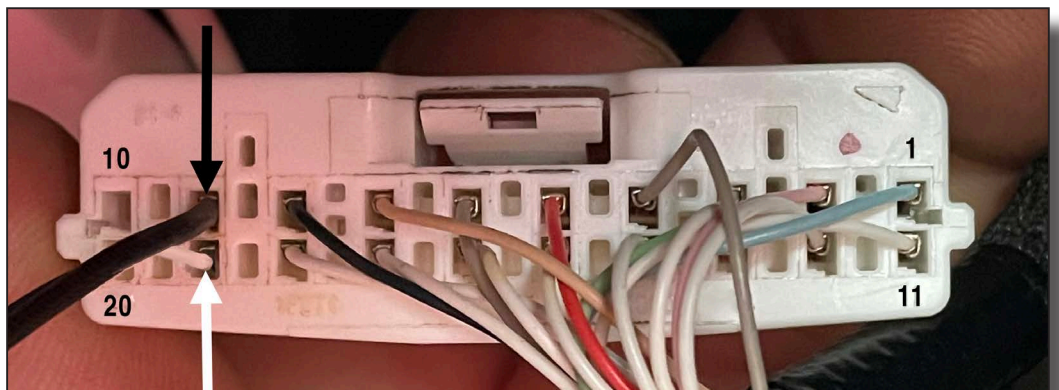

- 3.2.16.11 Push the TPA back into the connector so it is flush with the connector, locking the terminals in place. If the TPA doesn't sit flush or is difficult to push in, you probably need to push on the terminals to seat them properly.
- 3.2.16.12 Insert the CAN Connector back into its receptacle and remount in the vehicle.

- 3.2.16.13 Before securing the radio and dash parts, it is recommended that you continue with the installation to confirm the module is operational and can read the CAN signals first.
- 3.2.17 Select the position in the switch panel that you are going to use for the manual lock-up switch and remove the switch blank.
- 3.2.18 Insert the TCLU-SW-OEM loom into the rear of the switch using the green plug end of the loom. Match up the latch on the green plug with the guides in the switch. Then insert the loom and switch into the front side of the blank switch panel until the switch clicks into place. Press the button on the switch a few times to verify that the switch is free moving.



- 3.2.19 Connect the Switch Leg loom to the other end of the TCLU-SW-OEM loom
- 3.2.20 Connect the main harness to the Nomad Lock-Up Module. Push hard as this connector can be difficult to connect the first time. Then lock the connector in place by pushing the red CPA (Connector Position Assurance) towards the module.
- 3.2.21 Separate out the ECU leg of the main harness in preparation of routing to the OEM Transmission Control Module.
- 3.2.22 Mount the Nomad Lockup Module to the metal bracket under the air conditioning system in the passenger footwell. If this is not suitable for your variant, the module can be mounted anywhere you can find a suitable location as long as you can still reach all of the wiring connectors.

3.3. OEM ECU Wiring behind Glove Box

- 3.3.1 Similar to the CANBUS wiring, we have identified two variants of ECU wiring. We have narrowed down to the approx dates we believe are the cutoffs for each version however, we recommend comparing the image of the Top (F) connector with the F connector in your vehicle to find which diagram to follow.
- 3.3.2 ECU leg of the Lock-Up Harness can be trimmed down to a suitable length or you can cable tie up the excess wiring loom. The choice is yours.
- 3.3.3 Separate the six (6) wires into their two (2) groups.
Solenoid Wires = Yellow, Green, White, Brown
Power Wires = Red, Black
- 3.3.4 Use the following diagrams to wire in the appropriate wires into the vehicle ECU. Take note of the Solenoid wires require the OEM wires to be cut and then joined to the appropriate colour.
DO NOT CUT the OEM wires for the two Power wires.
These wires must be SPLICED in to the OEM wires only.
- 3.3.5 Please DO NOT use wire splicers, quick connects or scotch locks to join these wires. They MUST be soldered.



3.4. ECU Wiring Diagram for approx. Jun 2015 to Aug 2020

Jun 2015 - Aug 2020 - 2.8L Turbo Diesel

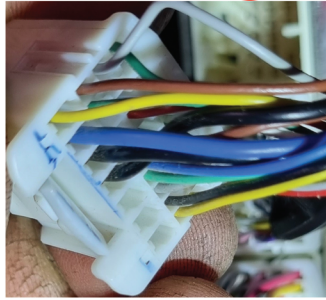

Use this diagram if your "F" connector has only ONE Blue wire across the top row as per photo

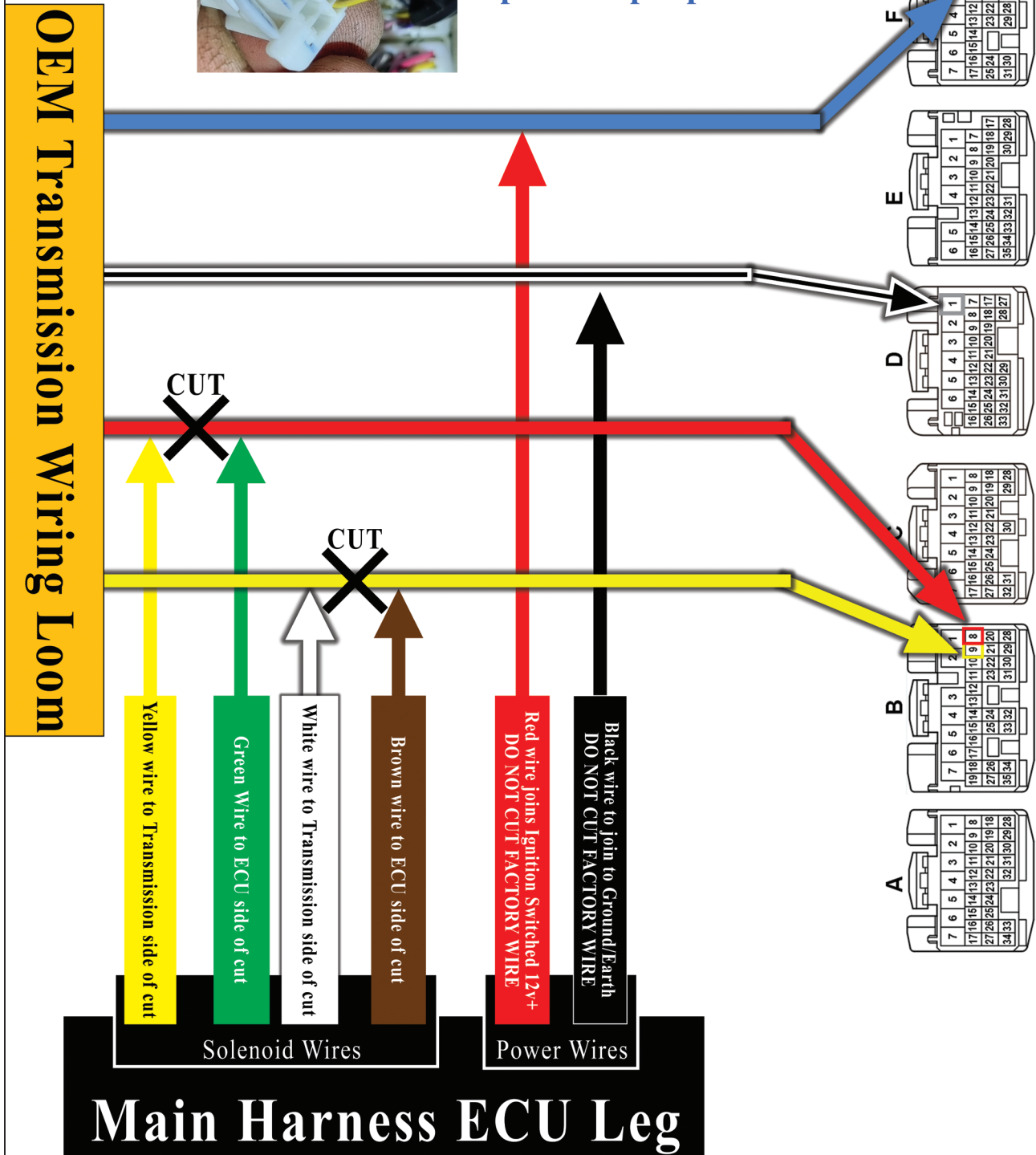

3.4.1 With batteries disconnected, remove the B connector from the ECU. Locate the two (2) OEM wires in Pins B8 and B9 in the OEM connector as per the wiring diagram. Separate them from the rest of the wiring loom by using a cable ties or electrical tape.

3.4.2 **Soldering to Solenoid Wire in B8**

3.4.2.1 Select the OEM wire in Pin B8, and approx 5cm from the connector, cut the wire. Do not cut the second OEM wire in Pin B9 yet.

3.4.2.2 Strip around 10mm of wire on each side of the cut.

3.4.2.3 In the Solenoid Wires group, locate the Green wire, then slide one (1) piece of 2mm black heat shrink onto the wire.

3.4.2.4 Solder the Green wire to the ECU side of the OEM cut wire in Pin B8. Slide the heat shrink over the join and heat to secure with hot air blower.

3.4.2.5 In the Solenoid Wires group, locate the Yellow wire, then slide one (1) piece of 2mm black heat shrink onto the wire.

3.4.2.6 Solder the Yellow wire to the Transmission side of the OEM cut wire in Pin B8. Slide the heat shrink over the join and secure with hot air blower.

3.4.3 **Soldering to Solenoid Wire in B9**

3.4.3.1 Select the OEM wire in Pin B9, and approx 5cm from the connector, cut the wire.

3.4.3.2 Strip around 10mm of wire on each side of the cut.

3.4.3.3 In the Solenoid Wires group, locate the Brown wire, then slide one (1) piece of 2mm black heat shrink onto the wire.

3.4.3.4 Solder the Brown wire to the ECU side of the OEM cut wire in Pin B9. Slide the heat shrink over the join and secure with hot air blower.

3.4.3.5 In the Solenoid Wires group, locate the White wire, then slide one (1) piece of 2mm black heat shrink onto the wire.

3.4.3.6 Solder the White wire to the Transmission side of the OEM cut wire in Pin B9. Slide the heat shrink over the join and secure with hot air blower.

3.4.3.7 Reinstall the Connector labelled B into the ECU

3.4.4 Soldering to Ground Wire in D1

- 3.4.4.1 Remove the Connector labelled D.
- 3.4.4.2 Locate the OEM wire in D1.
- 3.4.4.3 Approx 5cm from the connector, strip back the wire sheath.
DO NOT CUT THIS WIRE.
- 3.4.4.4 In the Power Wires group, locate the Black wire and solder this wire to the OEM wire in Pin D1.
- 3.4.4.5 Use electrical tape to cover the join to prevent shorting.
- 3.4.4.6 Reinstall the Connector labelled D into the ECU

3.4.5 Soldering to Power Wire in F2

- 3.4.5.1 Remove the Connector labelled F.
- 3.4.5.2 Select the OEM wire in Pin F2
- 3.4.5.3 Approx 5cm from the connector strip back the wire sheath.
DO NOT CUT THIS WIRE.
- 3.4.5.4 In the Power Wires group, locate the Red wire and solder this wire to the OEM wire in Pin F2.
- 3.4.5.5 Use electrical tape to cover the join to prevent shorting.
- 3.4.5.6 Reinstall the Connector labelled F into the ECU

3.5. ECU Wiring Diagram for approx. Sept 2020 onwards

Sept 2020 Onwards - 2.8L Turbo Diesel

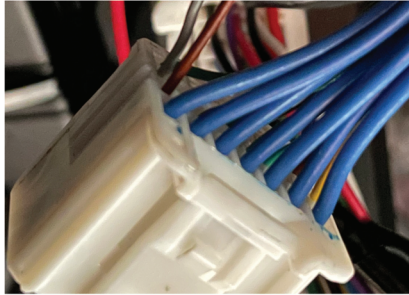

Use this diagram if your "F" connector has all Blue wires across the top row as per photo

OEM Transmission Wiring Loom

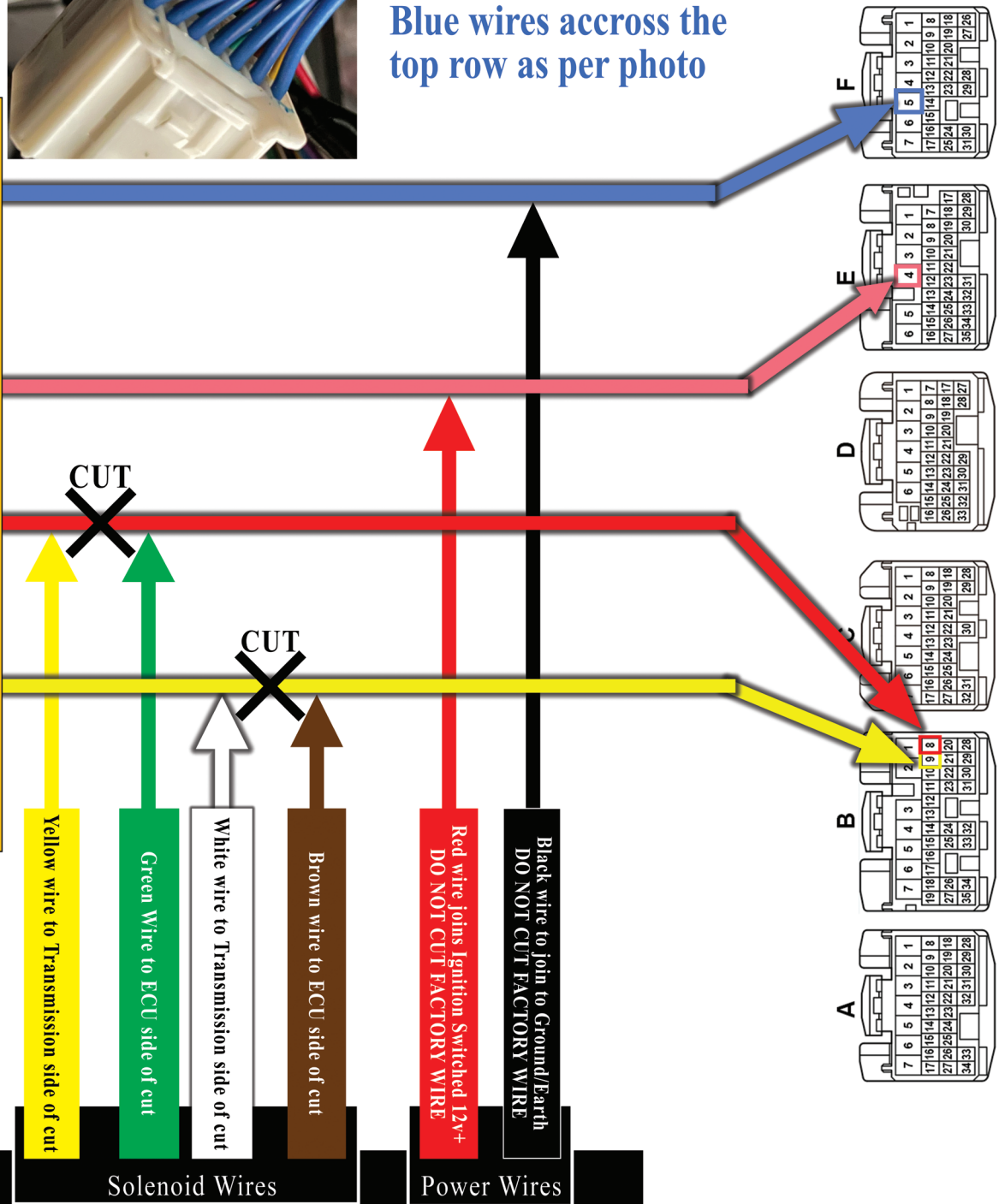

Main Harness ECU Leg

3.5.1 With batteries disconnected, remove the B connector from the ECU. Locate the two (2) OEM wires in Pins B8 and B9 in the OEM connector as per the wiring diagram. Separate them from the rest of the wiring loom by using a cable ties or electrical tape.

3.5.2 **Soldering to Solenoid Wire in B8**

3.5.2.1 Select the OEM wire in Pin B8, and approx 5cm from the connector, cut the wire. Do not cut the second OEM wire in Pin B9 yet.

3.5.2.2 Strip around 10mm of wire on each side of the cut.

3.5.2.3 In the Solenoid Wires group, locate the Green wire, then slide one (1) piece of 2mm black heat shrink onto the wire.

3.5.2.4 Solder the Green wire to the ECU side of the OEM cut wire in Pin B8. Slide the heat shrink over the join and heat to secure with hot air blower.

3.5.2.5 In the Solenoid Wires group, locate the Yellow wire, then slide one (1) piece of 2mm black heat shrink onto the wire.

3.5.2.6 Solder the Yellow wire to the Transmission side of the OEM cut wire in Pin B8. Slide the heat shrink over the join and secure with hot air blower.

3.5.3 **Soldering to Solenoid Wire in B9**

3.5.3.1 Select the OEM wire in Pin B9, and approx 5cm from the connector, cut the wire.

3.5.3.2 Strip around 10mm of wire on each side of the cut.

3.5.3.3 In the Solenoid Wires group, locate the Brown wire, then slide one (1) piece of 2mm black heat shrink onto the wire.

3.5.3.4 Solder the Brown wire to the ECU side of the OEM cut wire in Pin B9. Slide the heat shrink over the join and secure with hot air blower.

3.5.3.5 In the Solenoid Wires group, locate the White wire, then slide one (1) piece of 2mm black heat shrink onto the wire.

3.5.3.6 Solder the White wire to the Transmission side of the OEM cut wire in Pin B9. Slide the heat shrink over the join and secure with hot air blower.

3.5.3.7 Reinstall the Connector labelled B into the ECU

3.5.4 Soldering to Ground Wire in F5

- 3.5.4.1 Remove the Connector labelled F.
- 3.5.4.2 Locate the OEM wire in F5.
- 3.5.4.3 Approx 5cm from the connector, strip back the wire sheath.
DO NOT CUT THIS WIRE.
- 3.5.4.4 In the Power Wires group, locate the Black wire and solder this wire to the OEM wire in Pin F5.
- 3.5.4.5 Use electrical tape to cover the join to prevent shorting.
- 3.5.4.6 Reinstall the Connector labelled F into the ECU

3.5.5 Soldering to Power Wire in E4

- 3.5.5.1 Remove the Connector labelled E.
- 3.5.5.2 Select the OEM wire in Pin E4
- 3.5.5.3 Approx 5cm from the connector strip back the wire sheath.
DO NOT CUT THIS WIRE.
- 3.5.5.4 In the Power Wires group, locate the Red wire and solder this wire to the OEM wire in Pin E4.
- 3.5.5.5 Use electrical tape to cover the join to prevent shorting.
- 3.5.5.6 Reinstall the Connector labelled E into the ECU

3.6. Final tidy up

- 3.6.1 Tidy up the wires by using some electrical tape around the OEM and Lockup Harnesses. Also use cable ties to secure the looms to prevent them falling down or interfering with any moving parts.
- 3.6.2 Reconnect the battery terminals
- 3.6.3 This completes the wiring installation.
- 3.6.4 We recommend running through the Nomad Lockup Setup Wizard to verify everything is connected and working before re-installing any panels.

3.7. Lock-Up Module Bypass

- 3.7.1 If at any stage, you need to remove the Nomad Lock-Up Module, we have supplied a bypass connector that will take the place of the module so that your vehicle will not fault code while driving.
If you are fitting this unit on behalf of a customer, please leave this connector in the bag along with the QR code to access the User Guide. Please highlight this to your customer during handover.



- 3.7.2 To remove the Nomad Lock-Up Module or Bypass Connector, unlock the red CPA (Connector Position Assurance). Press down on the black clip to release. Then pull the two connectors apart.

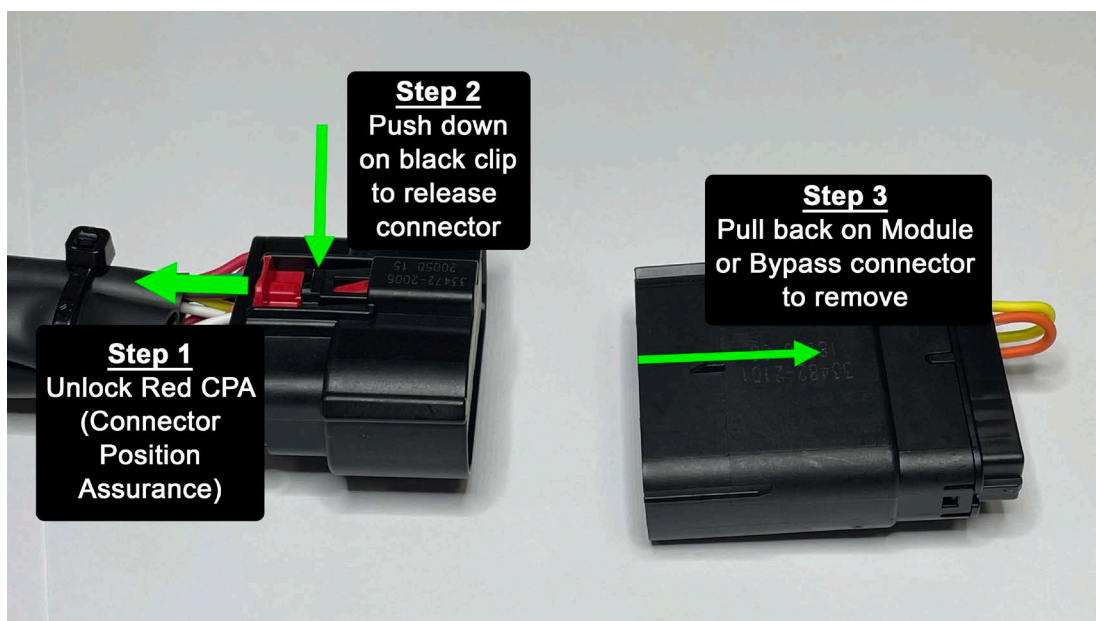

4. Downloading the Nomad Lock-Up App

4.1. Installing Nomad Lock-Up App onto Apple Devices

This chapter will cover finding, downloading and confirming that the Nomad Lock-Up App is ready to communicate with your Nomad Lock-Up Module using an Apple® mobile device.

The Nomad Lock-Up App is a free to download app available from the Apple® App Store®. You may require an Apple ID in order to download applications from the Apple® App Store®.

Minimum system requirements for your Apple mobile device to run the COMPUSHIFT Setup App are:

- Apple® iPhone® mobile digital device with iOS version 11 or later
- Apple® iPad® mobile digital device with iPadOS® version 11 or later
- Internet Access (only required for Firmware Update)

If your Apple mobile device operating system does not meet these requirements, you may not be able to download the app. Please follow the instructions provided by Apple® to update your devices operating system first then try downloading the Nomad Lock-Up app again.

4.1.1 On your Apple device, open the **App Store®** application.

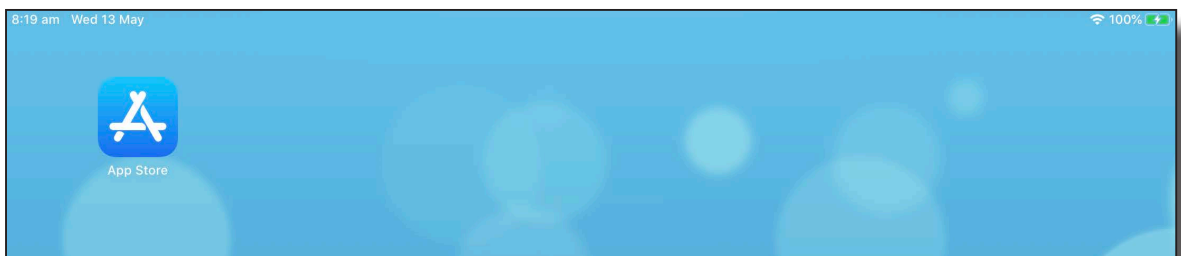

4.1.2 Tap on the **Search** button at the bottom of the App Store screen.

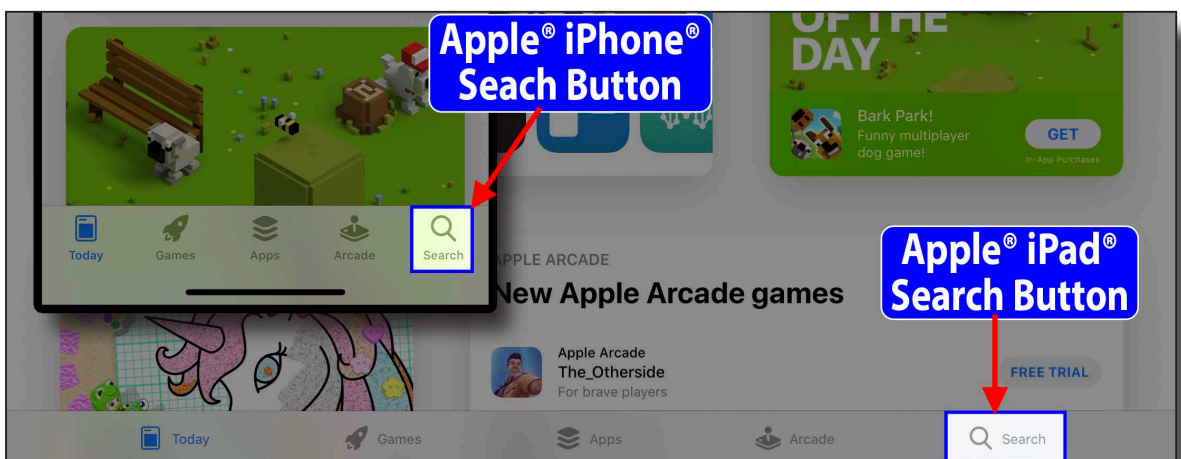

- 4.1.3 In the search field type “nomad lock” and press enter/search. Locate the app called **Nomad LockUp** in the results and tap on Get. You may be asked to enter your Apple ID® username and password details to download.

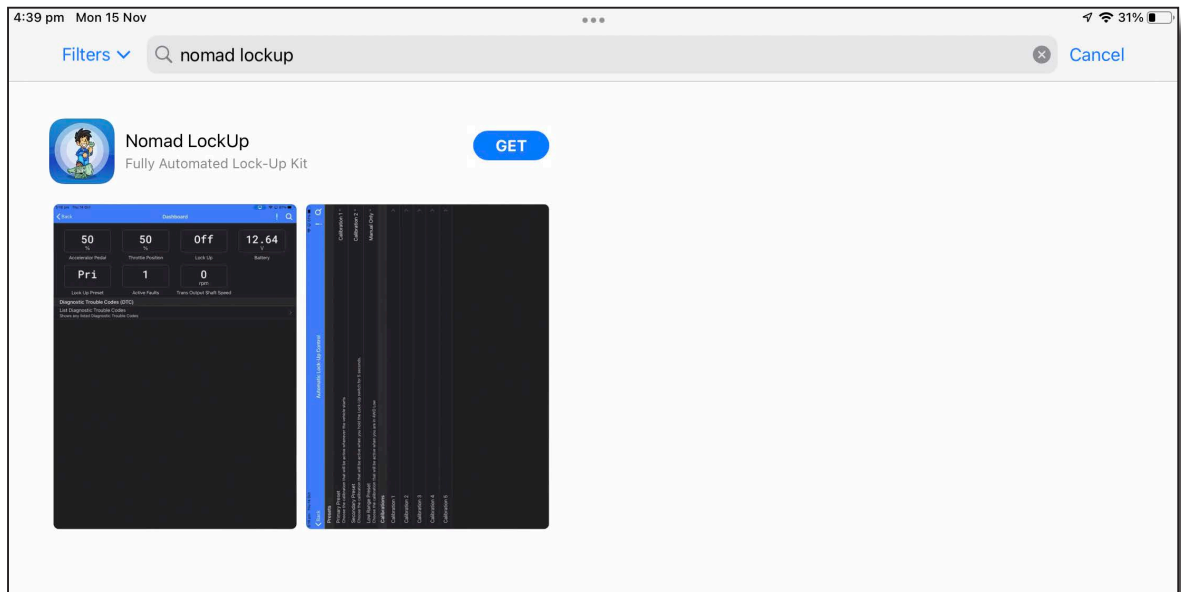

- 4.1.4 Once the App has finished downloading, tap on the icon to open. The first time you open the Nomad Lock-Up app, it will ask permission to use the devices Bluetooth® communication system to access the Nomad Lock-Up Module. Please select OK.

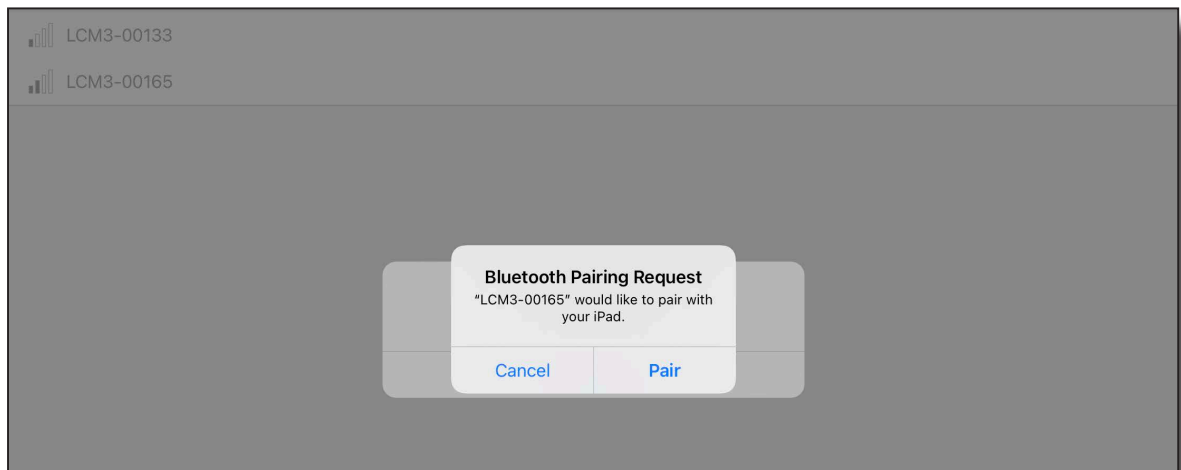

- 4.1.5 The App will now search for any Nomad Lock-Up Modules within range that are powered up. If you are not in range of your Nomad Lock-Up Module or it is not powered up, then the app will only show a spinning wheel indicating that there is no module in range.
- 4.1.6 If you have reached this step, then the app is installed and ready to connect to a Nomad Lock-Up Module.

4.2. Troubleshooting Installation on Apple Devices

If you have not made it to the final steps for the installation process, the following chapter will cover some basic troubleshooting steps to get you sorted.

- 4.2.1 If the App says '**! Bluetooth is Disabled**' then it means that the Bluetooth communication in your smart device is not functioning correctly. Most commonly this is due to the Bluetooth being turned off completely or it could be that the Nomad Lock-Up App has not been authorised to use Bluetooth yet.
- 4.2.2 First, close the app down and then quit the app by swiping up from the bottom or double pressing the home button and then swipe up on the app. Re-open the App. If the '**! Bluetooth is Disabled**' message still remains continue to the next step.

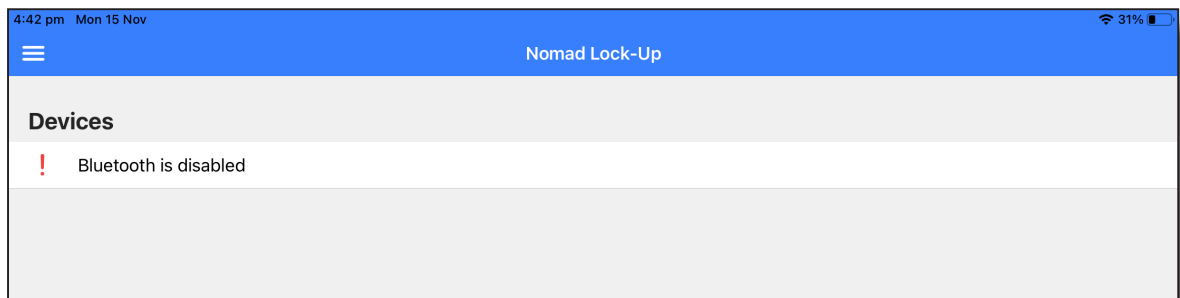

- 4.2.3 Open the Settings App and select Bluetooth. If Bluetooth is switched off, please turn it on. Close the settings app and re-open the Nomad Lock-Up App. You should no longer see the '**! Bluetooth is Disabled**' message, instead it should be replaced with the spinning wheel.

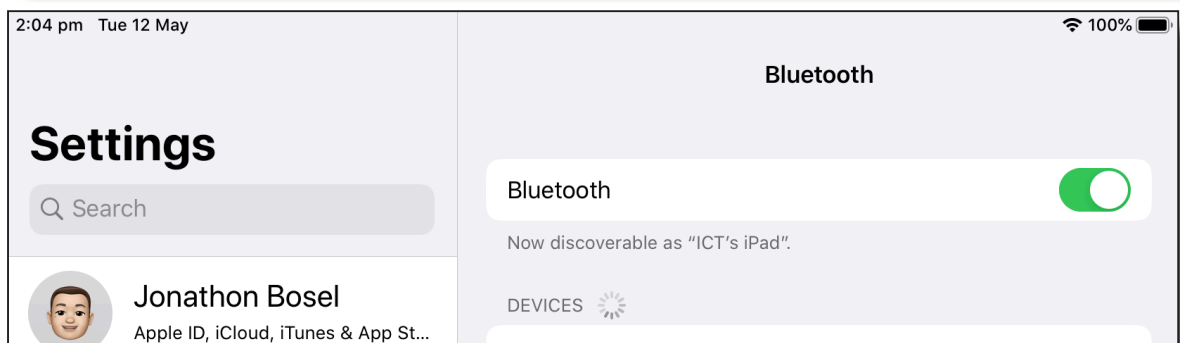
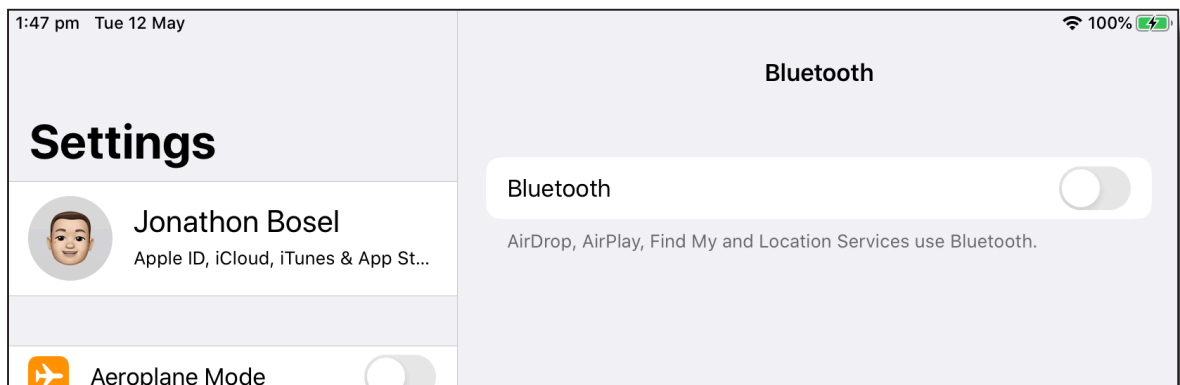

- 4.2.4 If you are still seeing the '**! Bluetooth is Disabled**' message, open the Settings App and scroll down the menu to Nomad LockUp. Tap on Nomad LockUp and verify that the Bluetooth access is enabled for the App. If not, switch access on. Return to the Nomad Lock-Up App and check you are no longer seeing the '**! Bluetooth is Disabled**' message, instead you should be seeing the spinning wheel.

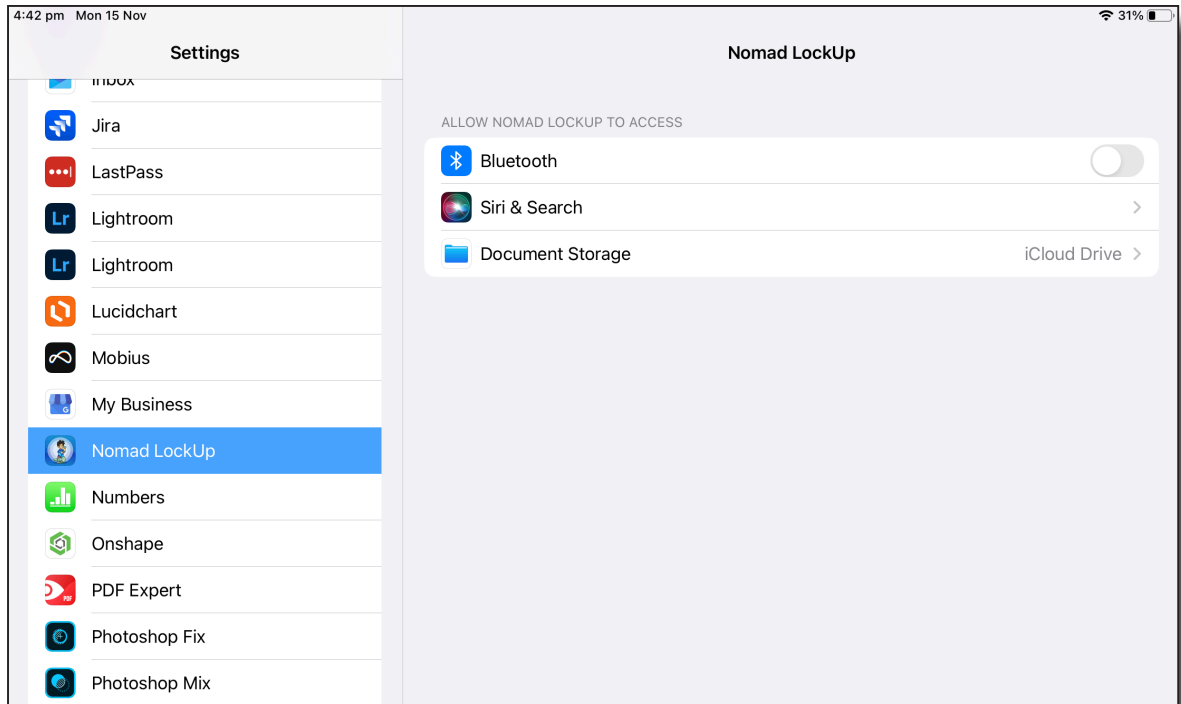

- 4.2.5 If none of these items have worked, please close the App. Tap and hold on the Nomad Lock-Up app icon and select Delete App. Then power your device off then on. Start from the beginning and download the app again.
- 4.2.6 If you are still unable to get rid of the '**! Bluetooth is Disabled**' message, please contact Wholesale Automatic Transmissions for further assistance.

4.3. Installing Nomad Lock-Up App onto Android Devices

This chapter will cover finding, downloading and confirming that the Nomad Lock-Up App is ready to communicate with your Nomad Lock-Up Module using an Android® mobile device.

The Nomad Lock-Up App is a free to download app available from the Google Play Store®. You may require a Google Account in order to download applications from the Google Play Store®.

Minimum system requirements for your Android® mobile device to run the Nomad Lock-Up App are:

- Android™ operating system version 4.4 or later
- Internet Access (only required for Firmware Update)

If your Android mobile device operating system does not meet these requirements, you may not be able to download the app. Please follow the instructions provided by your device manufacturer to update your devices operating system first then try downloading the Nomad Lock-Up app again.

If the operating system on your Android mobile device is unable to be updated to a compatible version, you will need to locate an alternative smart device that does meet the requirements.

You will require Internet access on your Android mobile device to download the Nomad Lock-Up app.

- 4.3.1 On your Android device, open the **Google Play Store**® application. Tap on the **Search** field at the top of the Google Play Store screen and type “nomad lockup”. Tap on the Nomad Lock-Up app to show the App page.

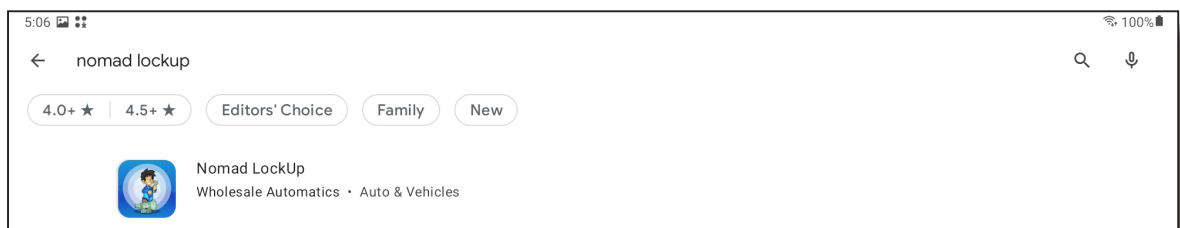

- 4.3.2 On the App page, tap on Install. This is a free app, you will not be charged.

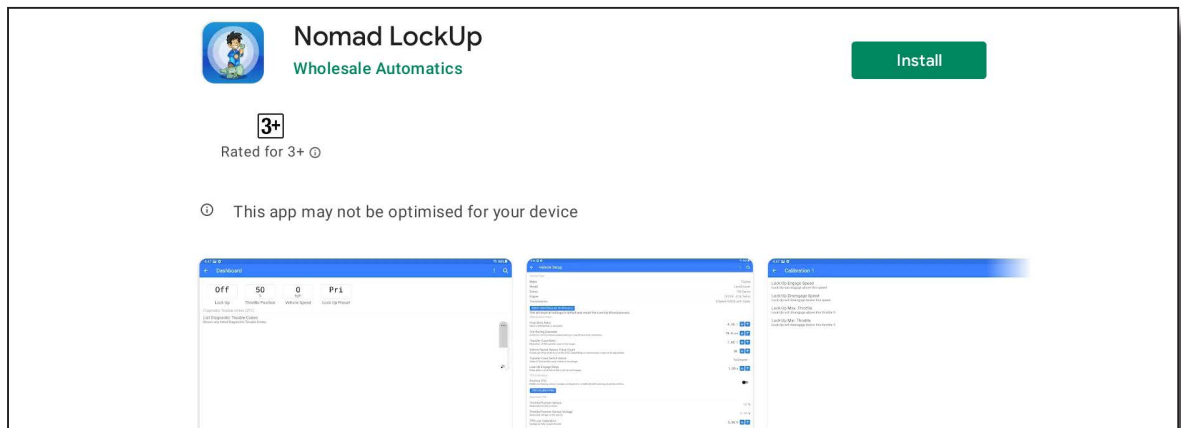

- 4.3.3 When the App opens for the first time, you will be asked to permission for the app to access the devices location. Tap on While using the App to continue.

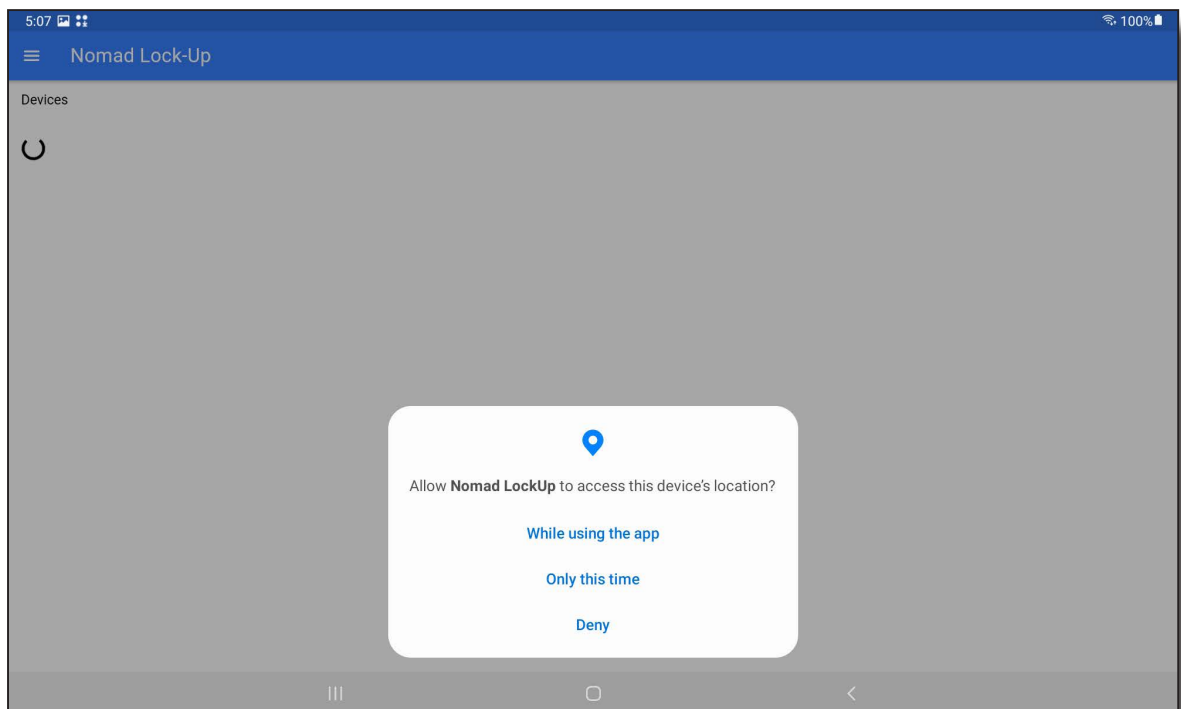

- 4.3.4 You should now see the devices page and a list of any Nomad Lock-Up Modules that are powered up and within range. If you are not in range of your Nomad Lock-Up Module or it is not powered up, then the app will only show a spinning wheel indicating that there is no module in range.

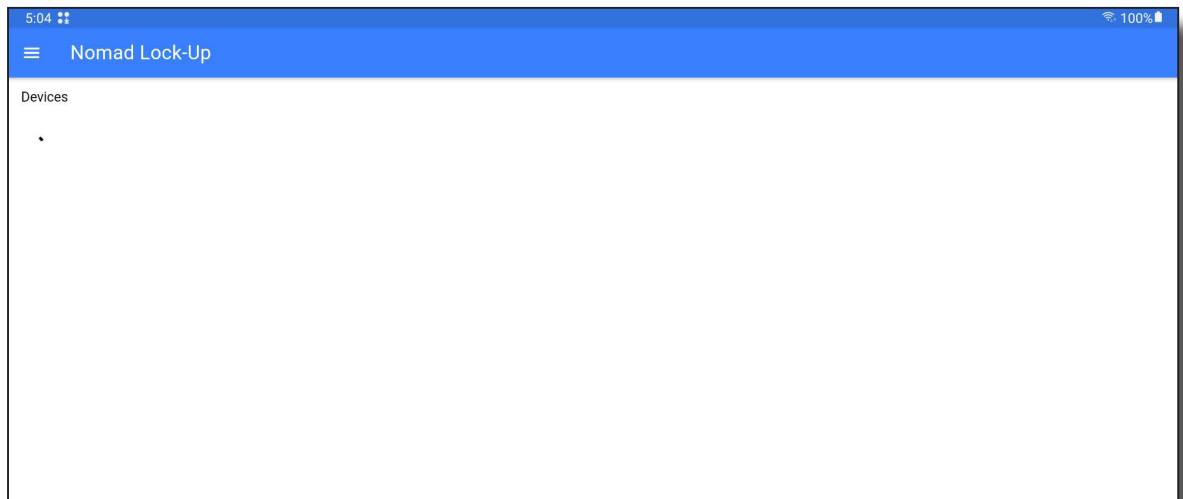

4.3.5 If you have reached this step, then the app is installed and ready to connect to a Nomad Lock-Up Module.

4.4. Troubleshooting Installation on Android Devices

If you have not made it to the final steps for the installation process, the following chapter will cover some basic troubleshooting steps to get you sorted.

- 4.4.1 If the App says '**! Bluetooth is Disabled**' then it means that the Bluetooth communication in your smart device is not functioning correctly. This could be because you app did not recognise that it has access to your Bluetooth system, Bluetooth is turned off completely or it could be that the Nomad Lock-Up Setup App has not been authorised to use Bluetooth yet.
- 4.4.2 First, close the app down completely by quitting the App. Re-open the App. If the '**! Bluetooth is Disabled**' message still remains continue to the next step.

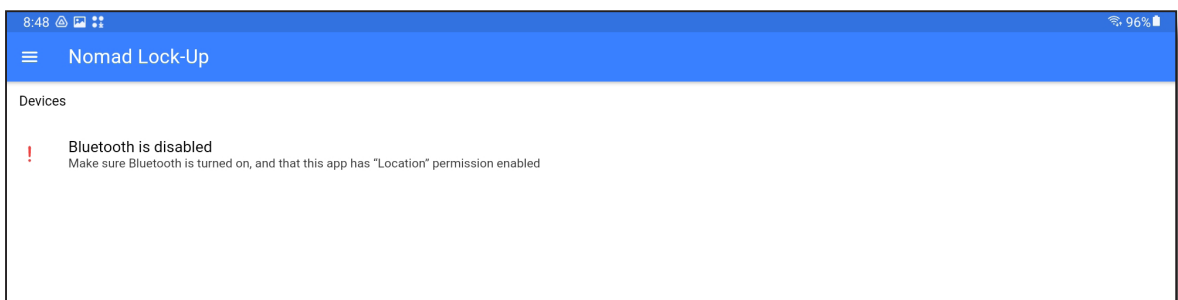

- 4.4.3 Swipe down from the top of the screen and tap on the grayed out Bluetooth icon. Close the settings window and force close the Nomad Lock-Up App. Re-Open the Nomad Lock-Up App, you should no longer see the '**! Bluetooth is Disabled**' message, instead it should be replaced with the spinning wheel.

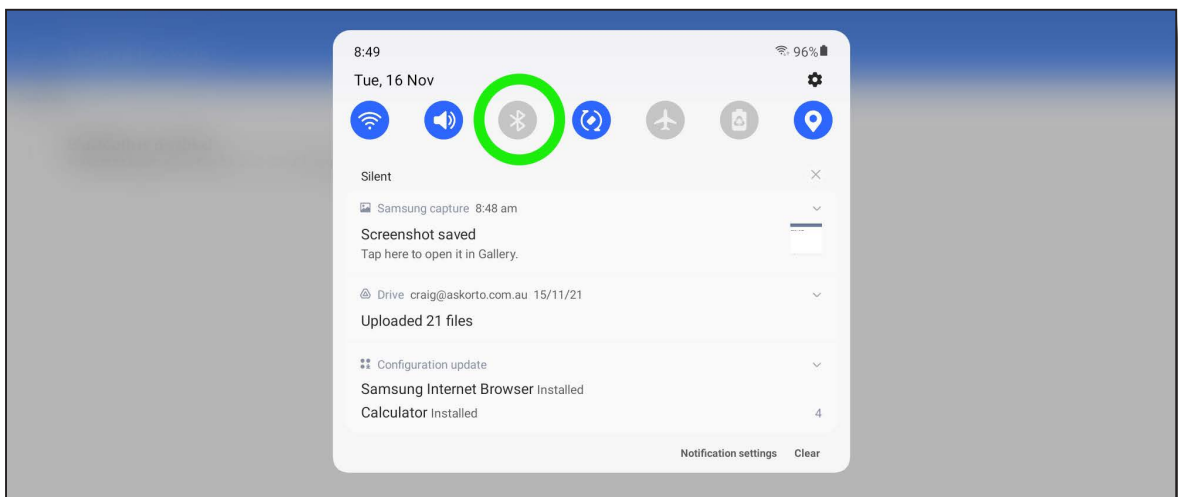

- 4.4.4 If you are seeing the '**Location services are Disabled**' message, this means that you have locations service switch off. This service is required for the app to function correctly.

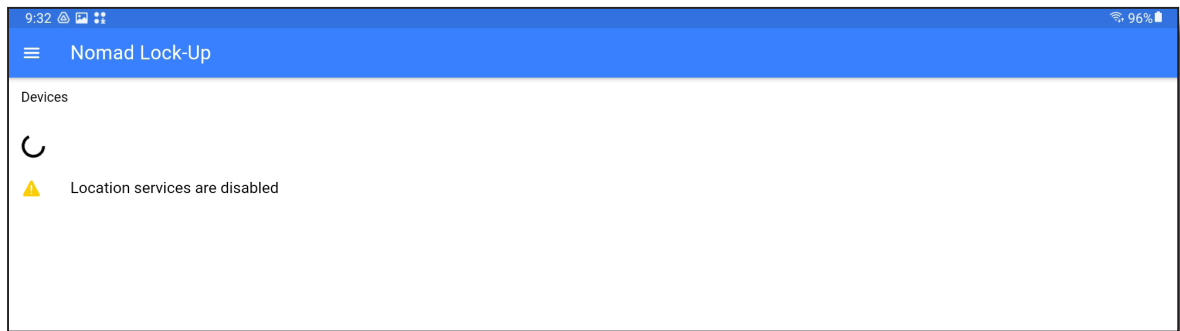

- 4.4.5 Swipe down from the top of the screen and tap on the grayed out Locations icon. This will turn Locations service on. Close the settings window and force close the Nomad Lock-Up App. Re-Open the Nomad Lock-Up App, you should no longer see the '**Location services are Disabled**' message, instead it should be replaced with the spinning wheel.

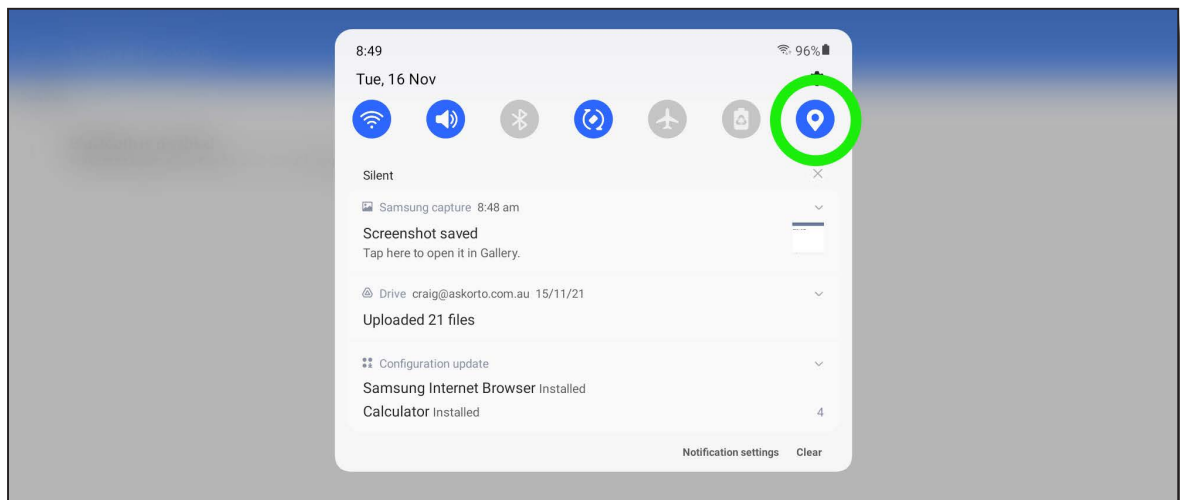

- 4.4.6 If none of these items have worked, please close the App. Tap and hold on the Nomad Lock-Up app icon and drag to the trash. Then power your device off then on. Start from the beginning and download the app again.
- 4.4.7 If you are still seeing the '**! Bluetooth is Disabled**' message or the '**Location services are Disabled**' message, please contact Wholesale Automatic Transmissions for further assistance.

5. Setup Wizard

5.1. First Connection and Firmware Update

- 5.1.1 Turn your vehicle's ignition on, but do not start the engine.
- 5.1.2 Open the Nomad Lock-Up Application
- 5.1.3 Tap on your Lock-Up module from the Devices list.

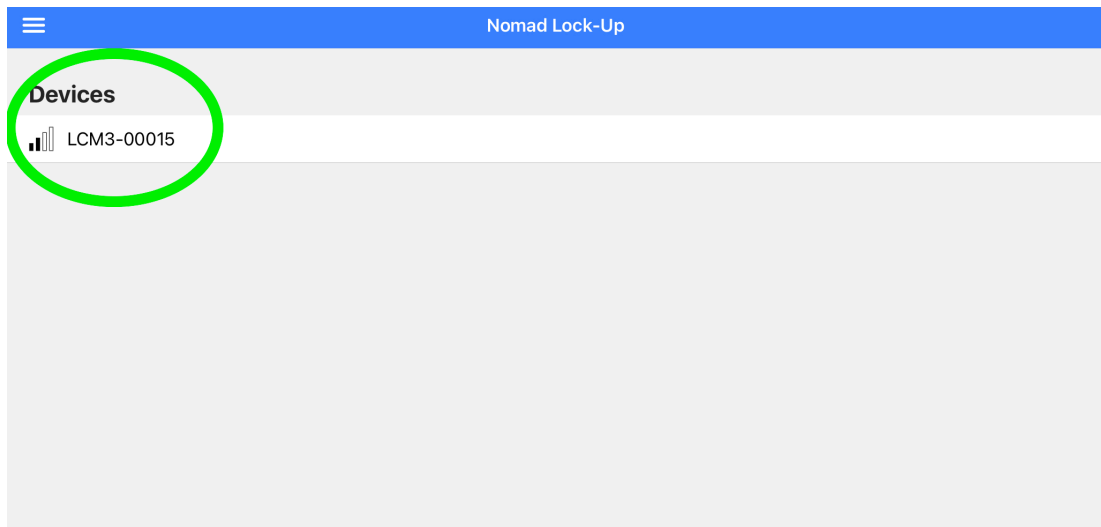

- 5.1.4 If this is the first time you have connected to the module you will be prompted to pair your device. Tap Pair.

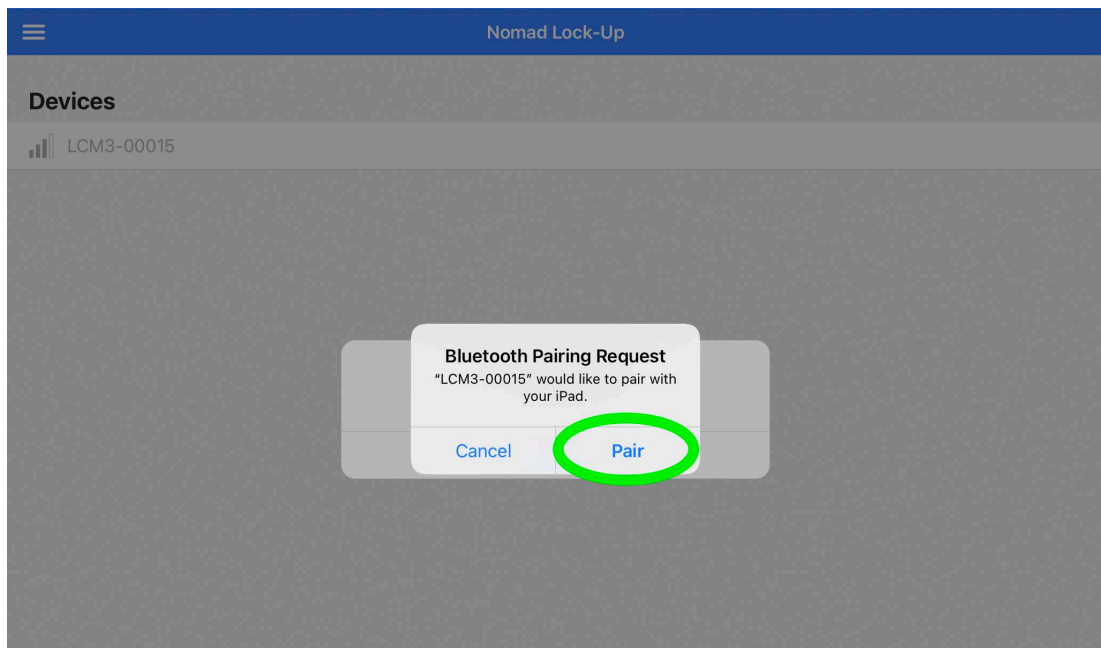

- 5.1.5 On initial connection, the Nomad Lock-Up app will check if there is a new version of firmware for the module. As we develop new vehicles and add features, we will provide the ability to update firmware as needed. If there is new firmware, you will see the following prompt. If your Nomad Lock-Up module is running the latest firmware, you can skip to the vehicle setup step.

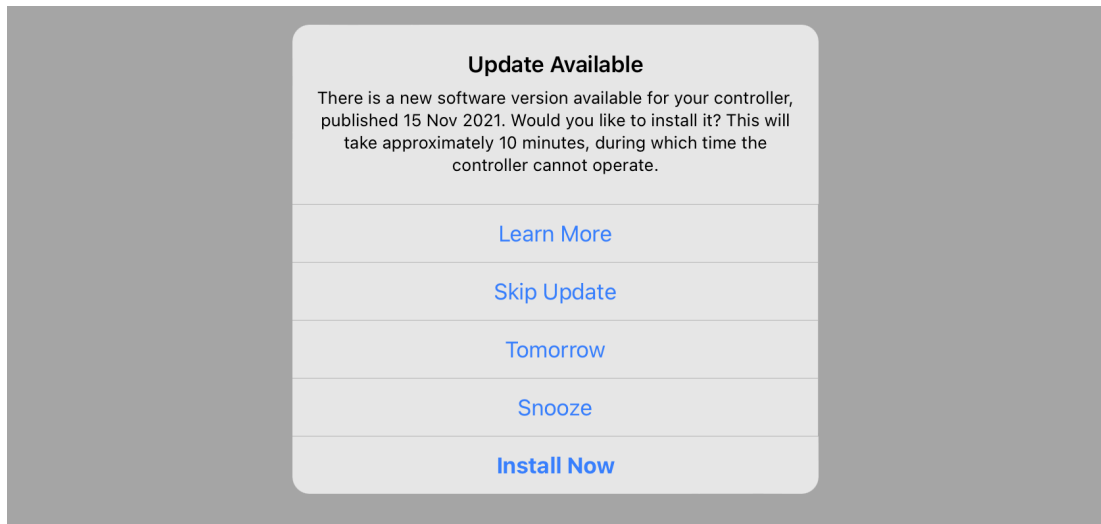

- 5.1.6 Tap on Install Now. This will take approx 10mins to download and install the latest firmware to ensure your Nomad Lock-Up module is up to date.
- 5.1.7 Please ensure your device does not go to sleep during this process. Also if you are using a phone, do not answer a call during this process as it will cause it to fail.

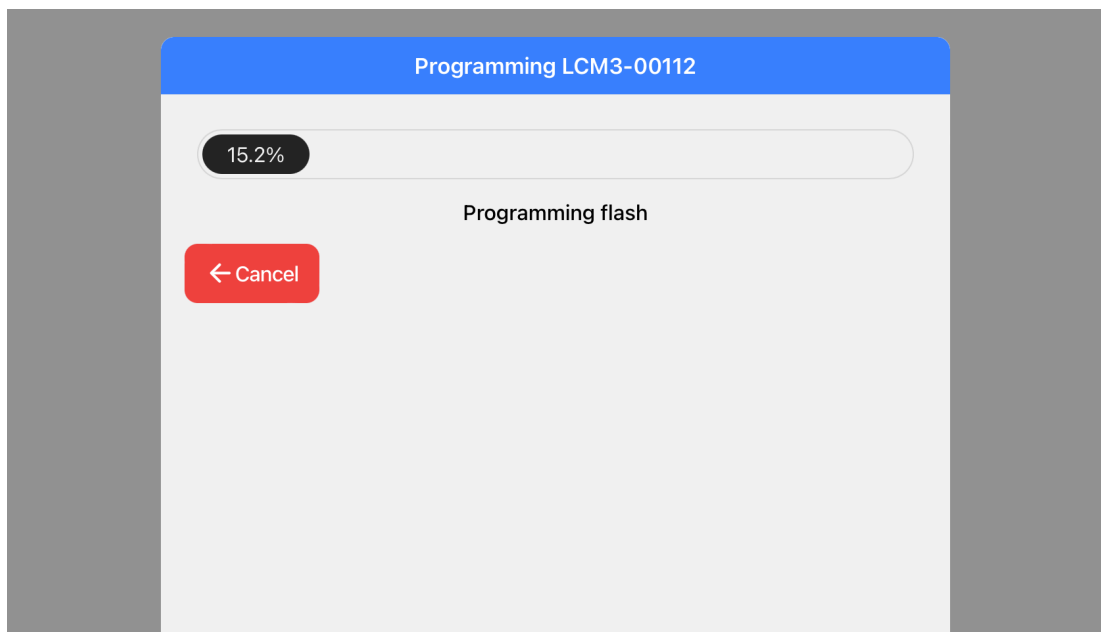

- 5.1.8 Once your modules firmware has been updated, you will be returned to the devices page. Tap on your device once more to connect.

5.2. Vehicle Configuration

- 5.2.1 The Setup Wizard, will ask you to select your vehicle configuration. In some cases we may prefill the following values due to them being the only option. Select “Apply Changes and Restart” to continue.

← Disconnect Setup Wizard

Select Vehicle Type

Make	→	Toyota ▾
Model	→	Hilux ▾
Series	→	8th Generation
Engine	→	1GD-FTV - 2.8L Turbo Diesel
Transmission	→	6 Speed AC60 Automatic

Once all settings are complete, please press Apply Changes and Restart to save the vehicle configuration to the Nomad Lock-Up controller and restart the controller with the new settings.

Apply Changes and Restart

← Back Continue →

- 5.2.2 Wait while the Nomad Lock-Up Module restarts

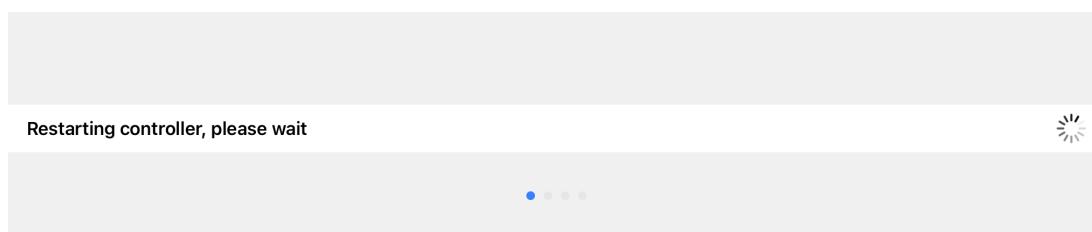

- 5.2.3 After the Nomad Lock-Up Module has rebooted, tap “Continue”

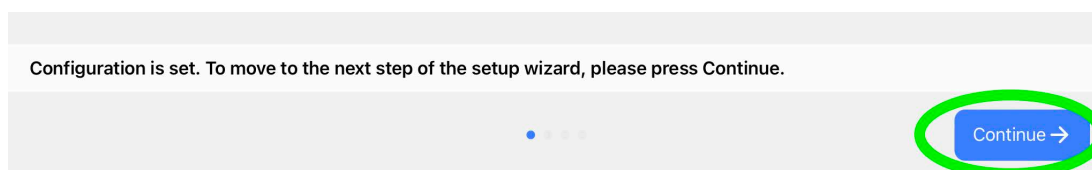

- 5.2.4 The Nomad Lock-Up Module will check for the necessary CANBUS signals that match your vehicle configuration. If Nomad Lock-Up Module detected issues, it will list the errors on the app. We recommend confirming that you have chosen the correct vehicle configuration. Also check that the CANBUS connections are correct and the position of the two wires in the CANBUS connector is correct. You can run the test again by tapping on Try Again.

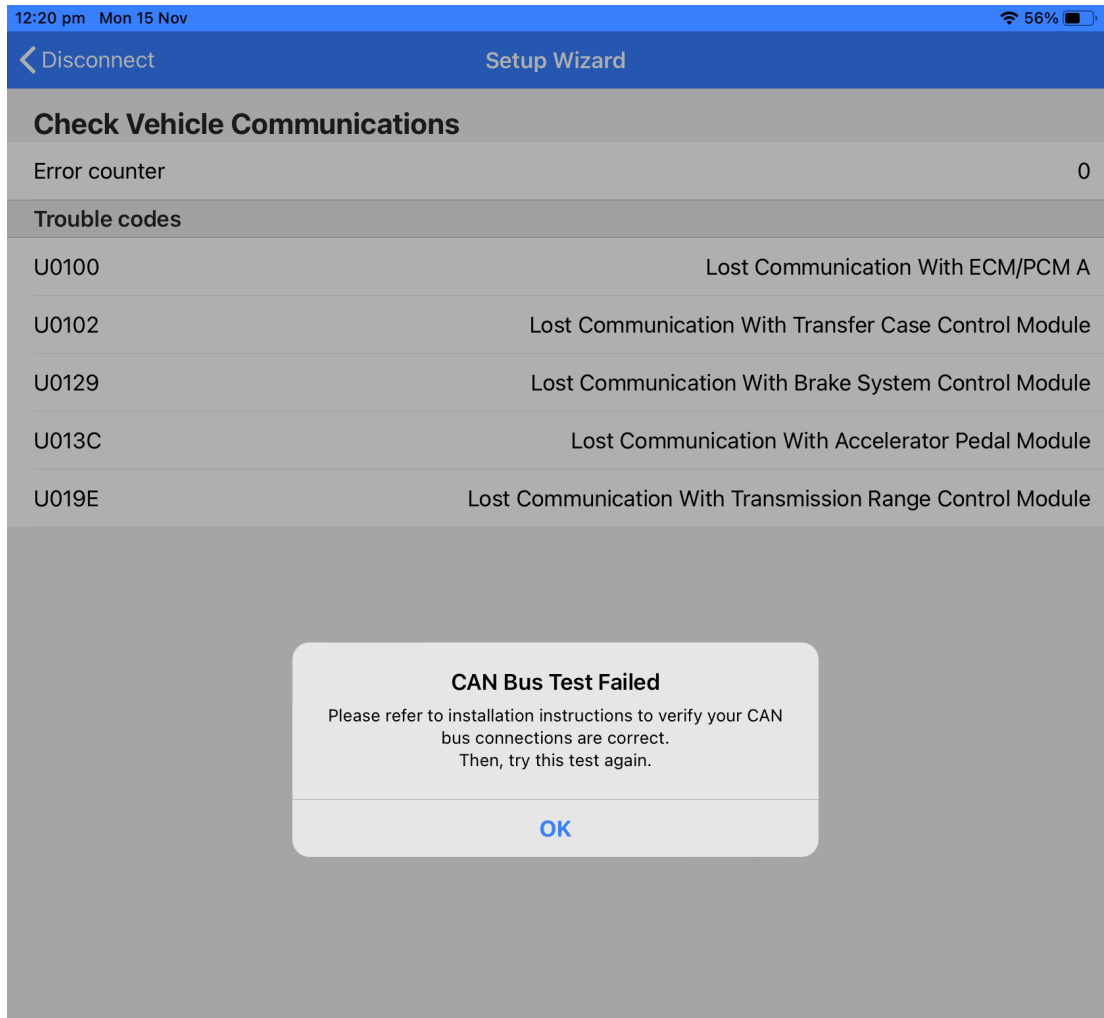

- 5.2.5 If all the CANBUS signals check out, you will see Test Passed and the continue button will be shown. Tap Continue.

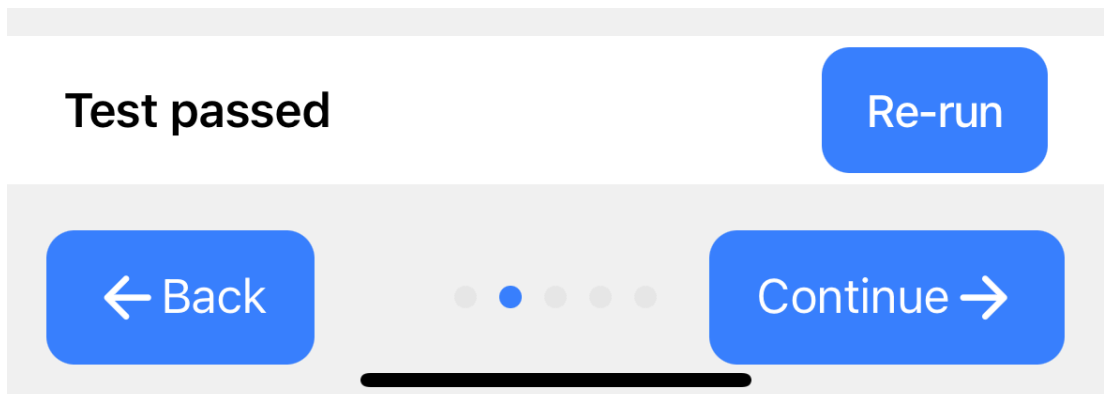

- 5.2.6 Checking Sensor Inputs allows you to verify that the signals the Nomad Lock-Up module requires to operate are being decoded correctly.

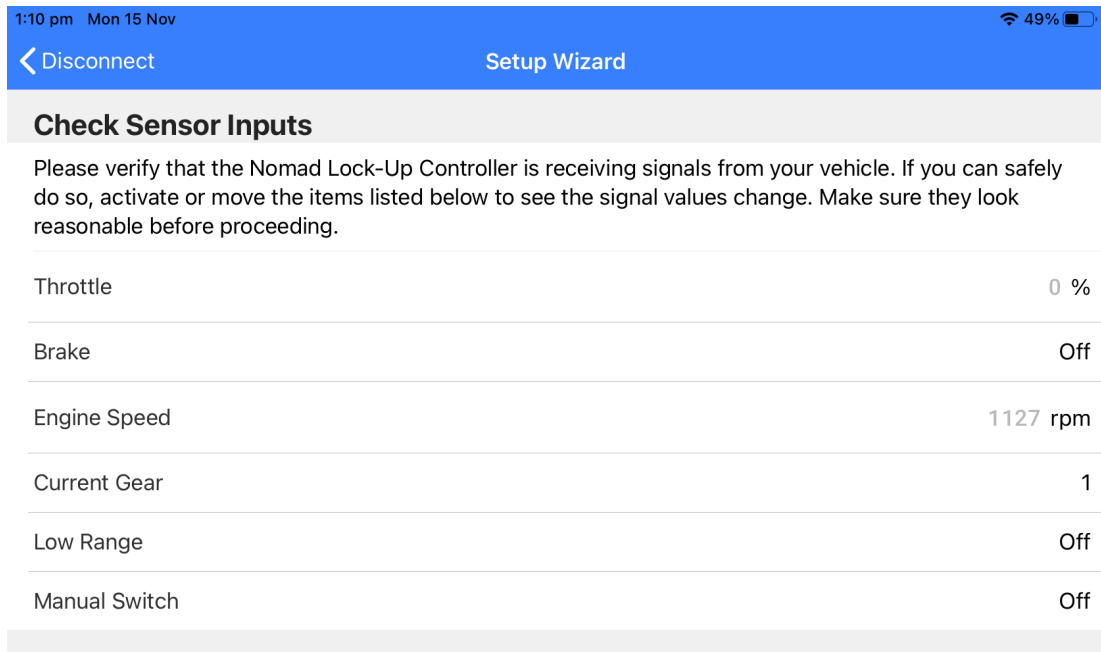

5.2.6.1 Throttle

Press down on the Accelerator Pedal and you should see the Throttle value increase and decrease according to the percentage of pedal movement.

5.2.6.2 Brake

Push down on the brake pedal to confirm we are receiving that signal.

5.2.6.3 Engine Speed

While you engine should be off, this should read 0. This confirms that the CANBUS signal is correct.

5.2.6.4 Current Gear

Move your shifter to Drive position and tap up/down to check the gear changes. You may have to press 2nd Start button in some variants.

5.2.6.5 Low Range

Check that the Module can detect when the vehicle is in Low Range. The Low Range value will change from "Off" to "On"

5.2.6.6 Manual Switch

Push the Lock-Up switch to check that the Manual Switch value will change from "Off" to "On"

- 5.2.7 Once all signals are confirmed, tap "Continue".

- 5.2.8 Choose if you would like the Nomad Lock-Up Module to operate in Automatic or Manual Mode. Then Tap continue. (more information below)

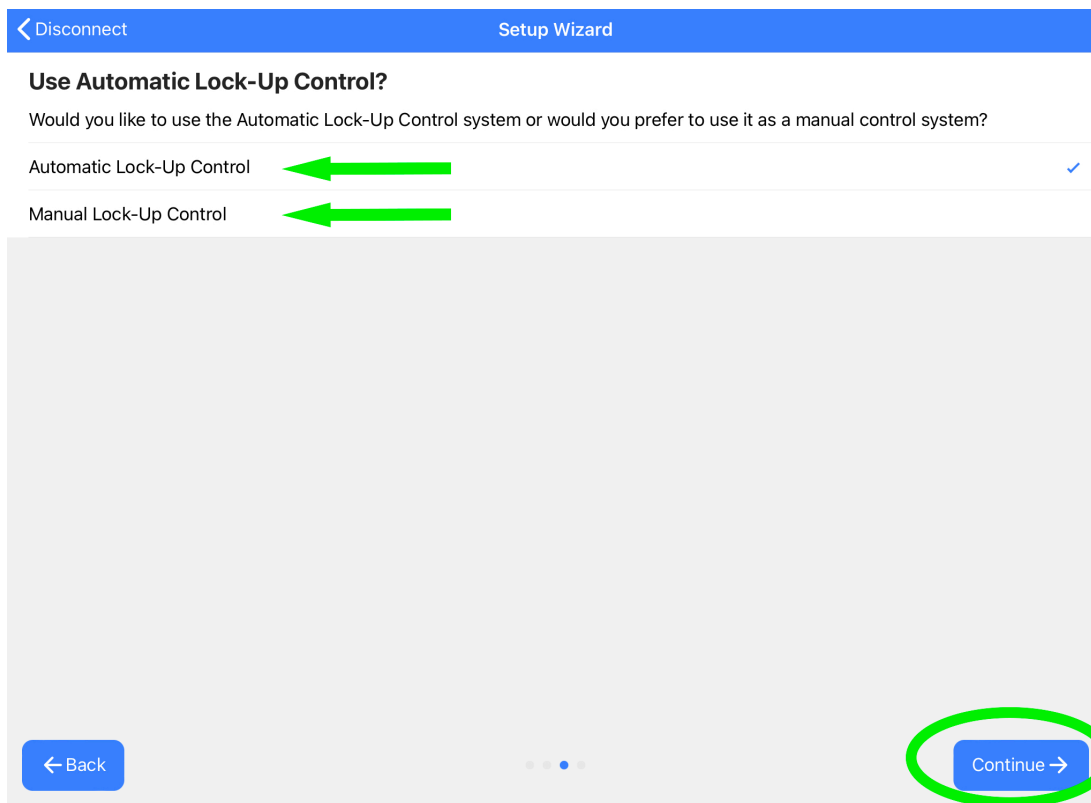

5.2.8.1 **Automatic mode**

The torque converter lock-up will automatically engage and disengage at predetermined speeds that we have configured for you. These values can be modified at anytime to suit your driving style. In Low Range the lock-up is still controlled manually via the switch.

This is the recommended setting for most people.

For more information about configuring the Nomad Lock-Up system, please check out our Nomad Lock-Up Users Guide. Link below.



5.2.8.2 **Manual mode**

You decide when the lock-up is engaged by toggling lock-up on and off via the manual switch. This will make the Nomad Lock-Up Module operate the same way as our previous GEN2 Lock-Up Kit.

- 5.2.9 Please set the Rolling Tire Diameter for your vehicle. To find Rolling Diameter, measure from the ground to the centre of the axle, then double.

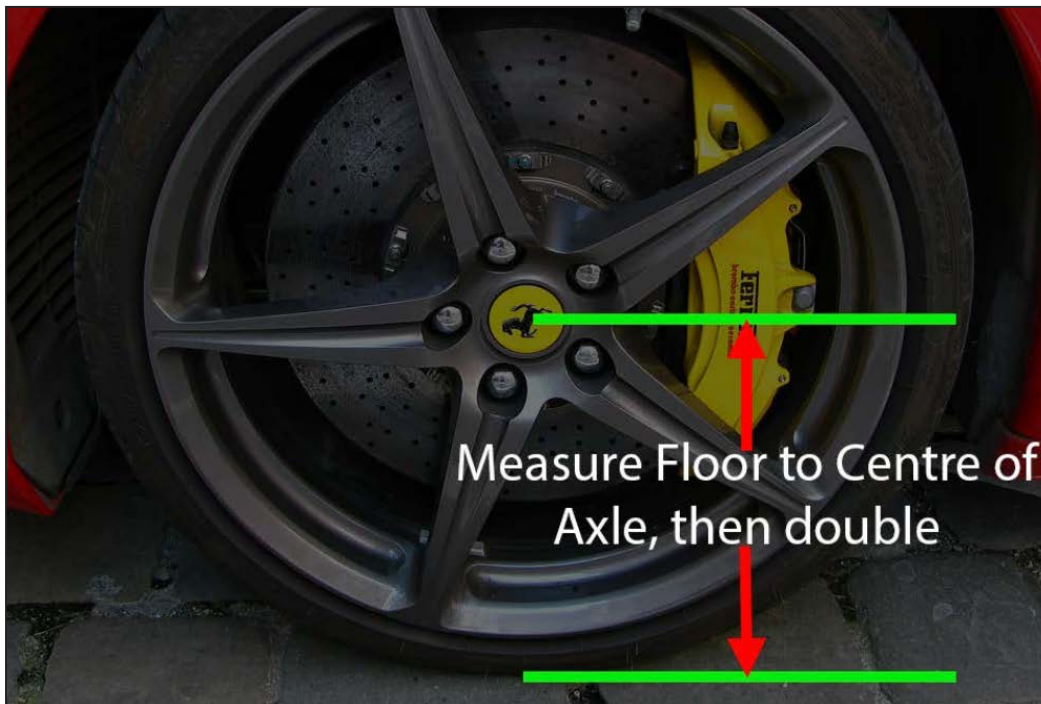
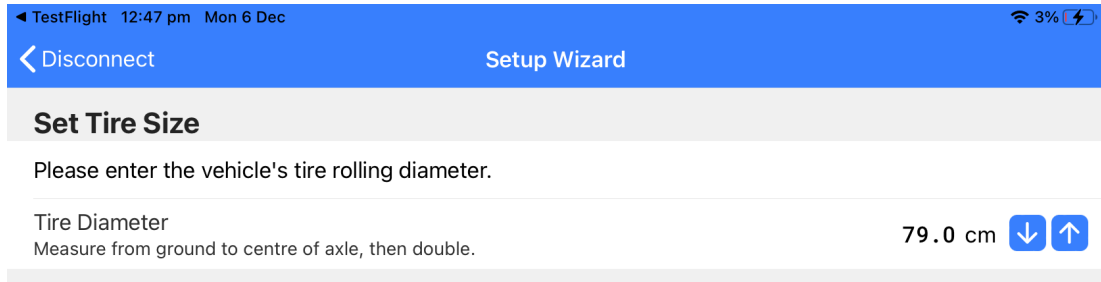

- 5.2.10 Tap “Finish” to complete the Setup Wizard

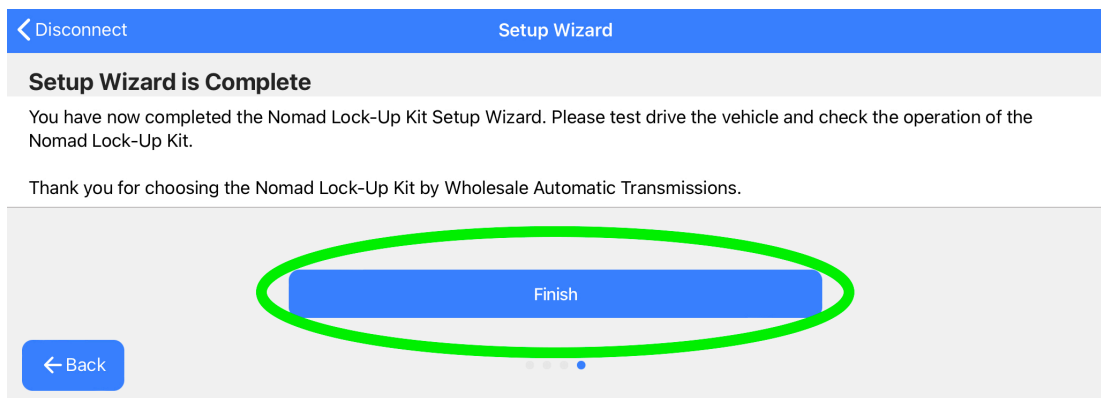

- 5.2.11 Leave the app open, while you switch off the vehicle, then start the vehicle back up again.

- 5.2.12 Allow time for the app to reconnect to the Nomad Lock-Up Module. Confirm there are no DTCs (Diagnostic Trouble Codes) set. If you see the Tick at the top right, you have completed the installation.

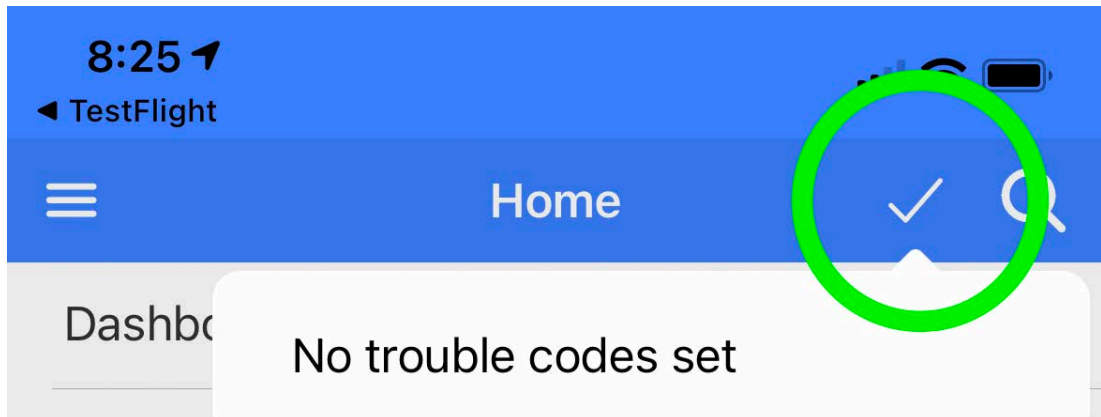

- 5.2.13 You can now take the vehicle for a test drive to confirm the Nomad Lock-Up kit is operating as expected. At this point, we recommend re-installing any dash panels or parts removed to install the Nomad Lockup Module.
- 5.2.14 After the test drive, before switching off the vehicle, connect to the Nomad Lock-Up Module with the app to confirm you still see the Tick at the top right.

This completes the Installation of the Nomad Lock-Up Kit

If you would like further information
on how to adjust all of the
calibration settings, please see
User Guide documentation on our
website using the QR code below or
tapping on the QR code.



Please Provide us with Feedback

If you have a minute to provide us with some feedback about your experience with Wholesale Automatic Transmissions and our products, that would be greatly appreciated.

Using your smart phone or device's camera app, point at the QR code below to take you straight to our feedback page for you to choose the most appropriate feedback method.

