



# Nomad Lock-Up Kit Installation Instructions

**Suitable for:**



**Toyota LandCruiser 105 Series  
with A442F 4 Speed Auto**

WITH THE FOLLOWING ENGINES:  
1FZ-FE 4.5L Petrol (1998 - 2007)  
1HZ 4.2L Diesel (1998 - 2007)

Please read through all of the instructions carefully before proceeding. If any of the information does not appear correct or the diagrams don't match your vehicle, please contact Wholesale Automatic Transmissions or your place of purchase.

# Table of Contents

<b>1. Parts List</b> .....	<b>3</b>
<b>2. Information to note prior to starting</b> .....	<b>4</b>
2.1. Electrical Safety.....	4
2.2. Identifying the Nomad Lock-Up Kit Parts.....	5
<b>3. Installing the Nomad Lock-Up Kit</b> .....	<b>7</b>
3.1. Recommended Mounting Location .....	7
3.2. Nomad Harness Preparation.....	8
3.3. Installing the Harness in the Cabin .....	8
3.4. 1FZ-FE TCM Connectors .....	10
3.5. 1FZ-FE TCM Wiring Diagram .....	11
3.6. 1HZ TCM Wiring Diagram .....	15
3.7. Mounting Nomad Module and Resistor .....	19
3.8. Installing the Harness in the Cabin - OEM Switch .....	20
3.9. Final Tidy Up .....	21
3.10. Lock-Up Module Bypass.....	22
3.11. Installing the Nomad LockUp app on Apple Devices .....	23
3.12. Troubleshooting Installation on Apple Devices.....	25
3.13. Installing the Nomad LockUp app on Android™ Devices .....	27
3.14. Troubleshooting Installation on Android Devices .....	29
<b>4. Setup Wizard</b> .....	<b>31</b>
4.1. First Connection and Firmware Update .....	31
4.2. Vehicle Configuration.....	33

# 1. Parts List

Nomad Lock-Up  
Module



Nomad Lock-Up  
Main Harness



LC105 OEM Style  
Momentary Switch

Horizontal Switch



Vertical Switch

OEM Switch Loom



Resistor Loom - 12P



Nomad Analogue Interface  
Loom



Module Bypass  
Connector



2 x Long Metal Self  
Tapping Screws



2 x Short Metal Self  
Tapping Screws



4 x 30mm Pieces of  
Black Heatshrink



20 x Cable Ties

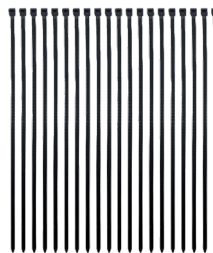

Getting Started Manual

**Wholesale**  
AUTOMATIC TRANSMISSIONS  
03-9762 8004  
**Installation Instructions**  
**Getting Started Guide**

Every year, thousands of unwanted printed pages ship with products that just end up in landfill. All of those documents took energy and resources to print - and pollute the earth. This is why Wholesale Automatic Transmissions are moving to electronic documentation for all our products.

Find your product and use your smart device's camera to scan the QR code on that page.



Estimated Install Time: 2 Hours

## 2. Information to note prior to starting

### 2.1. Electrical Safety

- 2.1.1 Disconnect all vehicle power sources including batteries, chargers and solar systems before starting the installation process.
- 2.1.2 The Load Resistor **MUST** be mounted to a metal surface clear of carpet, plastic or any material that could be damaged by heat. This resistor can reach temperatures over 50°C while in operation.

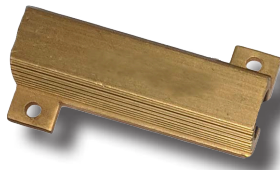

- 2.1.3 You can mount the Nomad module anywhere inside or outside the vehicle. The Nomad Module is IP68 rated so it can be mounted in the engine bay, however it must be away from heat sources such as turbos, exhausts and the engine block.

Also, take into consideration that the further away from the driver the module is mounted the lower the Bluetooth signal strength will be.

We recommend mounting the Nomad module inside the cabin.



- 2.1.4 The installation of this kit requires the fitter to have good knowledge of 12 volt wiring, an understanding of wiring schematics and good experience with soldering wires together. If you don't feel comfortable doing any of these tasks, then please contact one of our local Authorised Fitting Agents or your local Auto Electrician to have the unit installed professionally.

## 2.2. Identifying the Nomad Lock-Up Kit Parts

- 2.2.1 There are four (4) legs on the Nomad Lock-Up Harness (TCLU-HARNESS) that you need to be aware of. These legs define the purpose of the wires contained within.

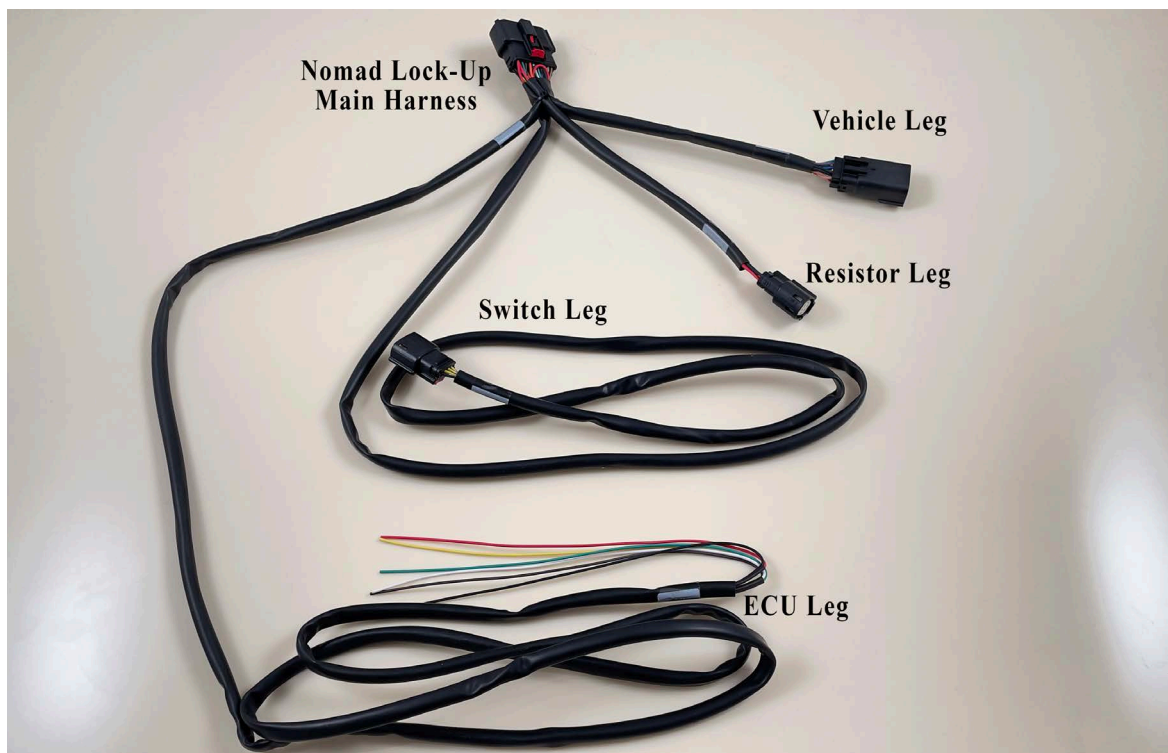

### 2.2.2 ECU Leg

This leg contains the wires that will be wired into the OEM Transmission Control Module (TCM). These wires connect to the Lock-Up Solenoid inside the transmission as well as picking up 12v+ Switched Power and Ground. If you feel there is too much wire on the ECU leg it can be trimmed back to a more suitable length. Just be conservative with your trimming as we don't recommend extending these wires.

The White and Brown wires are not required for the A442F transmission.

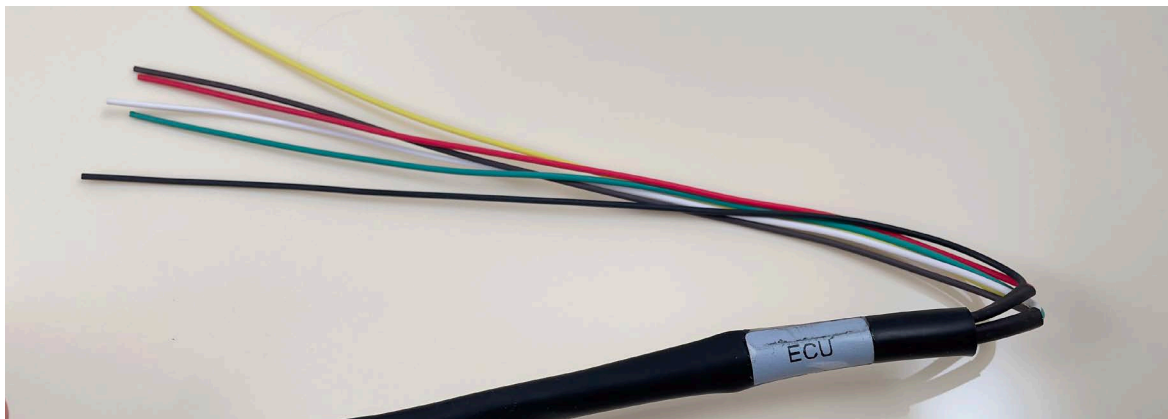

### 2.2.3 Switch Leg

This leg runs to where you plan to install the manual lock-up switch. This may use either a OEM style push switch or a Carling style rocker switch, depending on your vehicle's dash configuration.

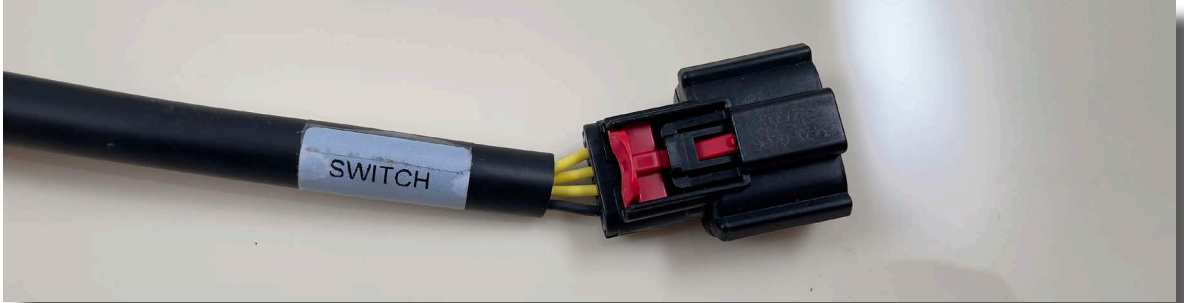

### 2.2.4 Resistor Leg

The resistor leg is one of the smaller legs of the Nomad harness. It provides a universal connection to the load resistor. This load resistor will vary depending on the transmission the Nomad Lock-Up Kit is controlling.



### 2.2.5 Vehicle Leg

Lastly, the vehicle leg. This leg is for the wires that will connect to various signals in your vehicle, depending on what vehicle you are installing the Nomad Lock-Up kit into. This may include Throttle Position Sensors (TPS), Vehicle Speed Sensors (VSS), or the vehicle's internal CAN bus.

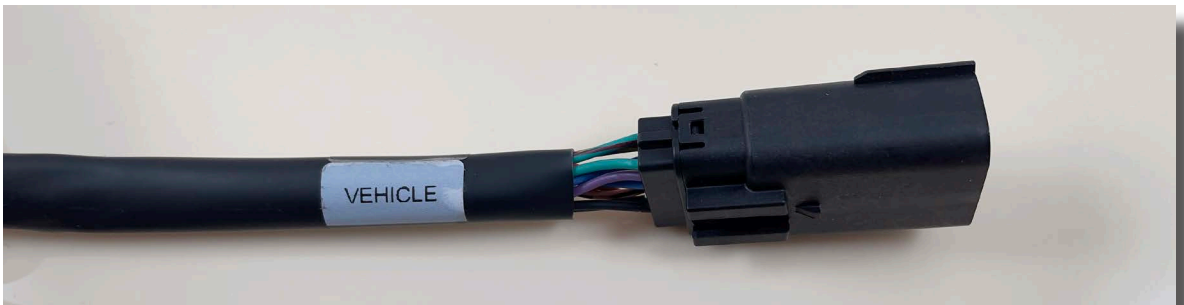

## 3. Installing the Nomad Lock-Up Kit

### 3.1. Recommended Mounting Location

- 3.1.1 While you are free to mount the various parts of the Nomad Lock-Up kit anywhere in your vehicle that you feel is the most appropriate, the installation instructions will assume you are mounting the parts in our recommended locations.

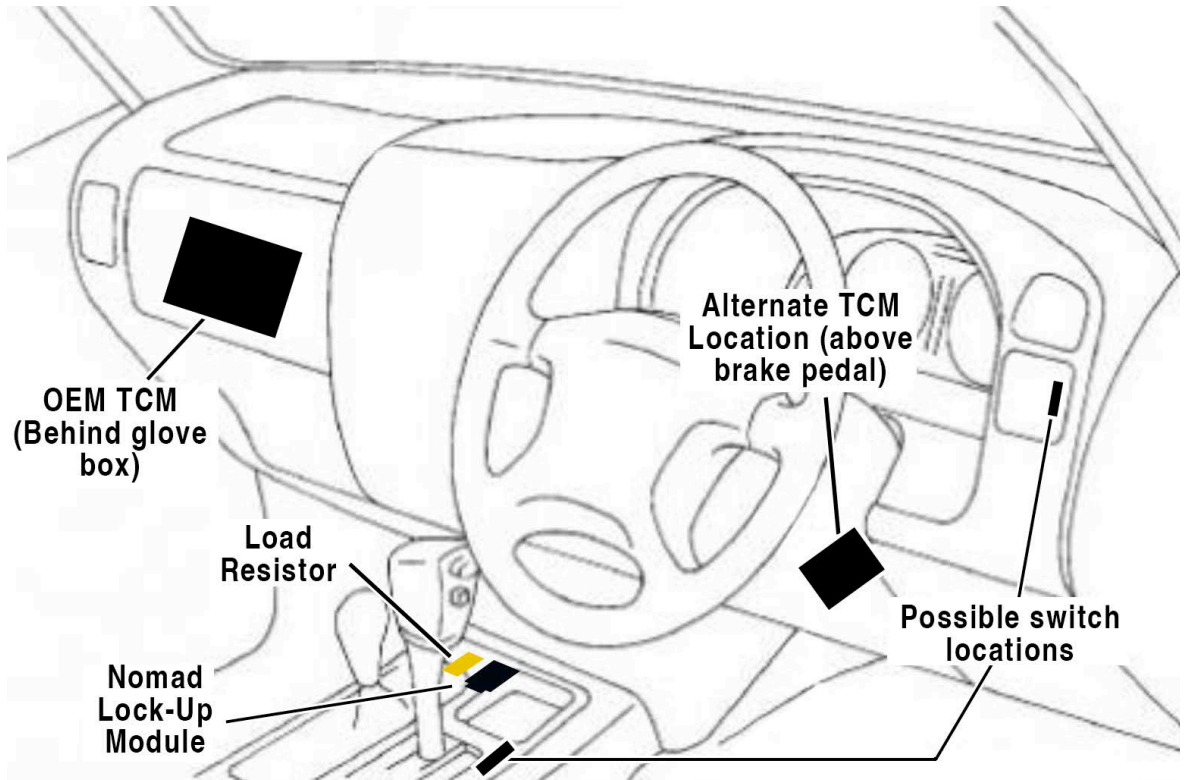

## 3.2. Nomad Harness Preparation

- 3.2.1 The Brown and White wires are not required for controlling the Torque Converter Clutch (TCC) in this vehicle variant. These need to be secured in such a way that they cannot short out to vehicle ground, or to each other.

Our recommended way of doing this is to cut back these two wire at slightly different lengths, then use a piece of electrical tape to keep these wires together and prevent them from shorting.

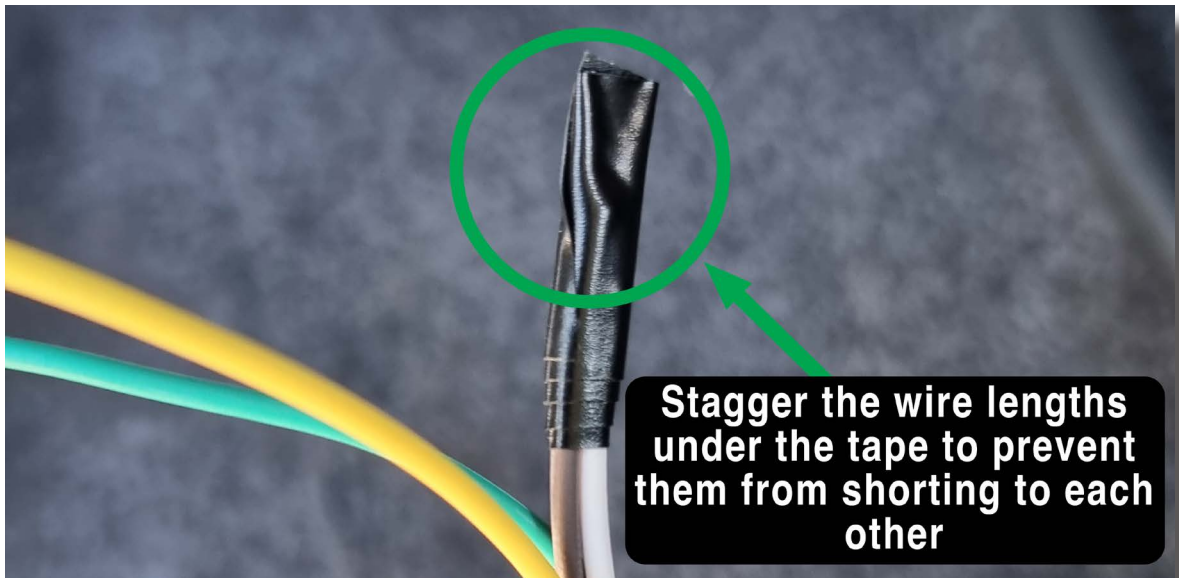

## 3.3. Installing the Harness in the Cabin

**\*\*Disconnect all vehicle power sources including starting and auxiliary batteries, chargers and solar systems before starting the installation process.\*\***

The resistor is used to dissipate energy from the OEM Transmission Control Module (TCM). As such, the resistor will get hot when the Nomad Lock-Up system is operating. This is expected behavior.

The resistor **MUST** be mounted to a flat, metal surface to aid in heat dissipation. It may cause damage to plastic or carpet if these materials come in contact with the resistor.

In the 105 Series we have found a good location for the load resistor is under the center console, near the shifter assembly. There is ample space in this area to mount the load resistor without having to worry about its heat damaging anything.

There is also space in this area to mount the Nomad module. Ultimately, however, this decision will be up to the installer as we are not able to account for accessories or slight variations in your model.



- 3.3.1 Start by gaining access to the OEM TCM. Remove the two Phillips head screws from the bottom of the glove box. Open the glove box, then squeeze the sides gently together to release the locking tabs and remove the glove box from the dash.

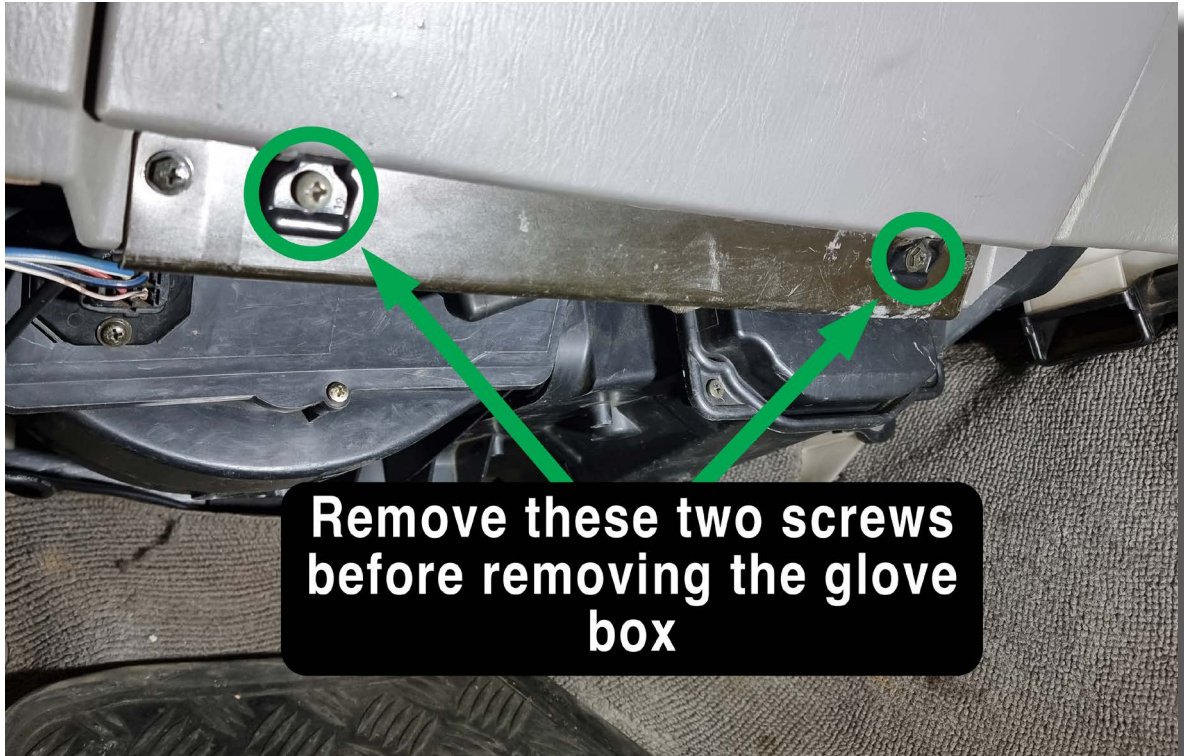

- 3.3.2 Remove the three Phillips screws holding the rear glove box surround. Be careful of the wiring for the glove box switch, as it won't allow you to pull this piece out far without first unplugging the connector.

There is an airbag connector behind an access panel on the right hand side of the panel. The connector is mounted to the access panel and they can be removed while still connected by unclipping the panel and feeding it back through the hole.



### 3.4. 1FZ-FE TCM Connectors

- 3.4.1 The TCM in the 105 Series with the 1FZ-FE Petrol engine is a part of the ECU, which is mounted vertically under the dash behind the glove box on the passenger side of the vehicle with 3 connectors plugged into it. Make sure there are no power sources connected to the vehicle (including auxiliary batteries and solar panels) before removing any of these connectors.

The wiring diagram on the following page shows the TCM connectors when looking at them from the harness side.

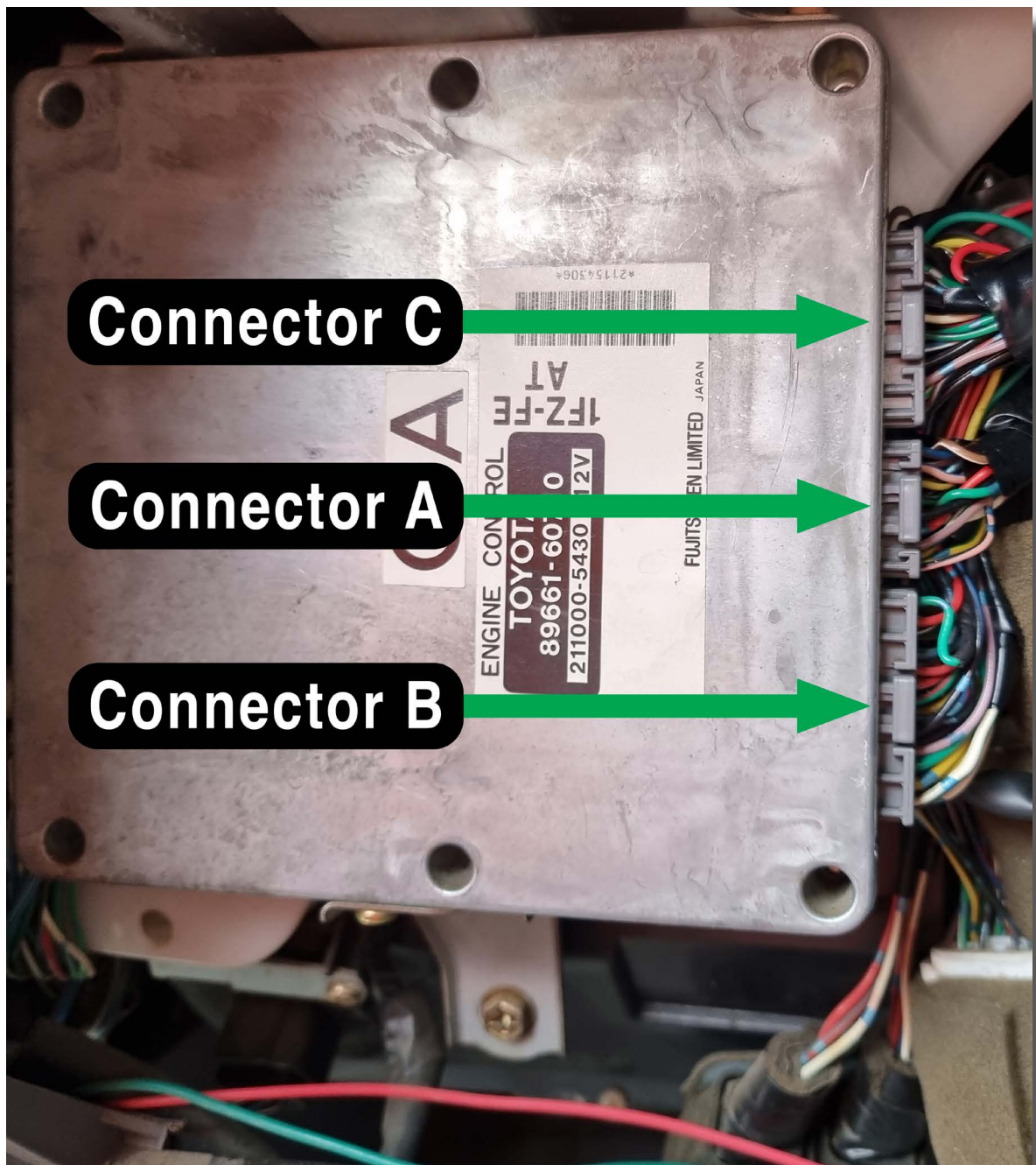

### 3.5. 1FZ-FE TCM Wiring Diagram

If the wiring in your vehicle does NOT match the information below, please STOP and contact Wholesale Automatics tech support.

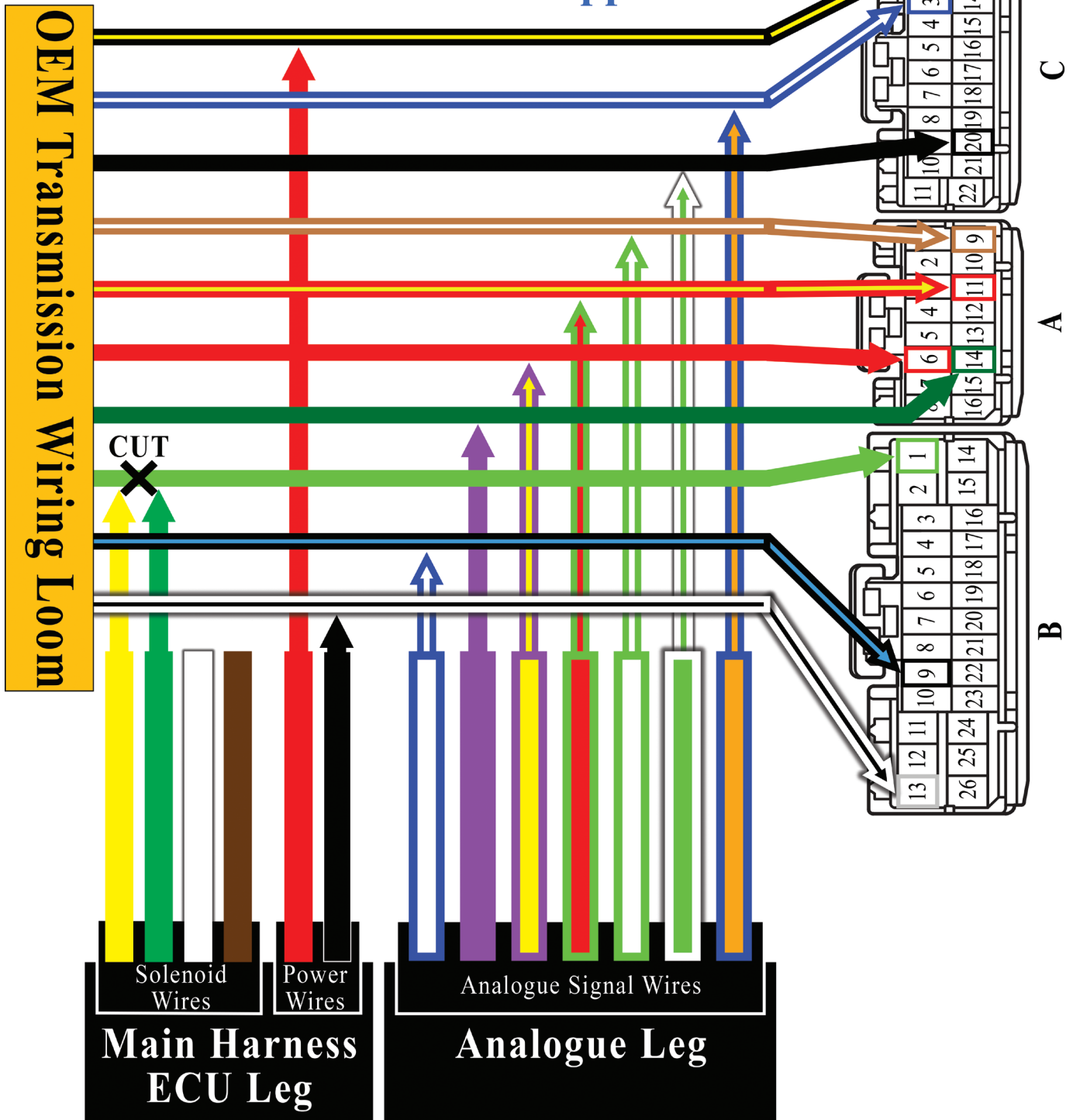

- 3.5.1 We suggest working on the ECU wiring one connector at the time. You can do these in any order, but make sure all power sources in the vehicle are disconnected before unplugging any of the connectors.
- 3.5.2 Please DO NOT use wire splicers, quick connects or scotch locks to join these wires. They MUST be soldered for reliable operation.



### 3.5.3 Soldering to Power wire in pin C12

- 3.5.3.1 Select the OEM wire in pin C12. Remove approximately 1cm of the wire sheath to expose the copper conductors about 5cm away from the connector. DO NOT cut this wire.
- 3.5.3.2 In the Power Wires group, locate the Red wire and solder this wire to the OEM wire in pin C12.
- 3.5.3.3 Use electrical tape to insulate the join and prevent shorting.

### 3.5.4 Soldering to Signal wire in pin C3

- 3.5.4.1 Select the OEM wire in pin C3. Remove approximately 1cm of the wire sheath to expose the copper conductors about 5cm away from the connector. DO NOT cut this wire.
- 3.5.4.2 Select the Blue-Orange wire from the Nomad Analogue Interface Loom. Solder this wire to the OEM wire in pin C3.
- 3.5.4.3 Use electrical tape to insulate the join and prevent shorting.

### 3.5.5 Soldering to Signal wire in pin C20

- 3.5.5.1 Select the OEM wire in pin C20. Remove approximately 1cm of the wire sheath to expose the copper conductors about 5cm away from the connector. DO NOT cut this wire.
- 3.5.5.2 Select the White-Green wire from the Nomad Analogue Interface Loom. Solder this wire to the OEM wire in pin C20.

3.5.5.3 Use electrical tape to insulate the join and prevent shorting.

### 3.5.6 **Soldering to Signal wire in pin A9**

3.5.6.1 Select the OEM wire in pin A9. Remove approximately 1cm of the wire sheath to expose the copper conductors about 5cm away from the connector. DO NOT cut this wire.

3.5.6.2 Select the Green-White wire from the Nomad Analogue Interface Loom. Solder this wire to the OEM wire in pin A9.

3.5.6.3 Use electrical tape to insulate the join and prevent shorting.

### 3.5.7 **Soldering to Signal wire in pin A11**

3.5.7.1 Select the OEM wire in pin A11. Remove approximately 1cm of the wire sheath to expose the copper conductors about 5cm away from the connector. DO NOT cut this wire.

3.5.7.2 Select the Green-Red wire from the Nomad Analogue Interface Loom. Solder this wire to the OEM wire in pin A11.

3.5.7.3 Use electrical tape to insulate the join and prevent shorting.

### 3.5.8 **Soldering to Signal wire in pin A6**

3.5.8.1 Select the OEM wire in pin A6. Remove approximately 1cm of the wire sheath to expose the copper conductors about 5cm away from the connector. DO NOT cut this wire.

3.5.8.2 Select the Violet-Yellow wire from the Nomad Analogue Interface Loom. Solder this wire to the OEM wire in pin A6.

3.5.8.3 Use electrical tape to insulate the join and prevent shorting.

### 3.5.9 **Soldering to Signal wire in pin A14**

3.5.9.1 Select the OEM wire in pin A14. Remove approximately 1cm of the wire sheath to expose the copper conductors about 5cm away from the connector. DO NOT cut this wire.

3.5.9.2 Select the Violet wire from the Nomad Analogue Interface Loom. Solder this wire to the OEM wire in pin A14.

3.5.9.3 Use electrical tape to insulate the join and prevent shorting.

### 3.5.10 Soldering to Solenoid Wire in B1

- 3.5.10.1 Select the OEM wire in pin B1 and cut it approximately 5cm from the connector. Strip about 1cm of insulation from each wire to expose the copper.
- 3.5.10.2 Locate the Green wire in the Solenoid Wires group and slide one (1) piece of 2mm black heat shrink onto the wire. Solder the Green wire to the TCM side of the OEM cut wire in pin B1. Slide the heat shrink over the join and use a heat source to shrink it.
- 3.5.10.3 Locate the Yellow wire in the Solenoid Wires group slide one (1) piece of 2mm black heat shrink onto the wire. Solder the Yellow wire to the transmission side of the OEM cut wire in pin B1. Slide the heat shrink over the join and use a heat source to shrink it.

### 3.5.11 Soldering to Signal wire in pin B9

- 3.5.11.1 Select the OEM wire in pin B9. Remove approximately 1cm of the wire sheath to expose the copper conductors about 5cm away from the connector. DO NOT cut this wire.
- 3.5.11.2 Select the Blue-White wire from the Nomad Analogue Interface Loom. Solder this wire to the OEM wire in pin B9.
- 3.5.11.3 Use electrical tape to insulate the join and prevent shorting.

### 3.5.12 Soldering to Ground wire in pin B13

- 3.5.12.1 Select the OEM wire in pin B13. Remove approximately 1cm of the wire sheath to expose the copper conductors about 5cm away from the connector. DO NOT cut this wire.
- 3.5.12.2 Select the Black wire from the Power Wires group. Solder this wire to the OEM wire in pin B13.
- 3.5.12.3 Use electrical tape to insulate the join and prevent shorting.

- 3.5.13 Reinstall all connectors into the TCM. Use electrical tape and the included cable ties to secure the Nomad wiring to the TCM wiring harness.

### 3.6. 1HZ TCM Wiring Diagram

3.6.1 The TCM in the 105 Series 1HZ Diesel engine is a part of the ECU, and is mounted either behind the glove box or above the brake pedal. There are two connectors plugged into it. Remove all power sources before unplugging these connectors.

**If the wiring in your vehicle does NOT match the information below, please STOP and contact Wholesale Automatics tech support.**

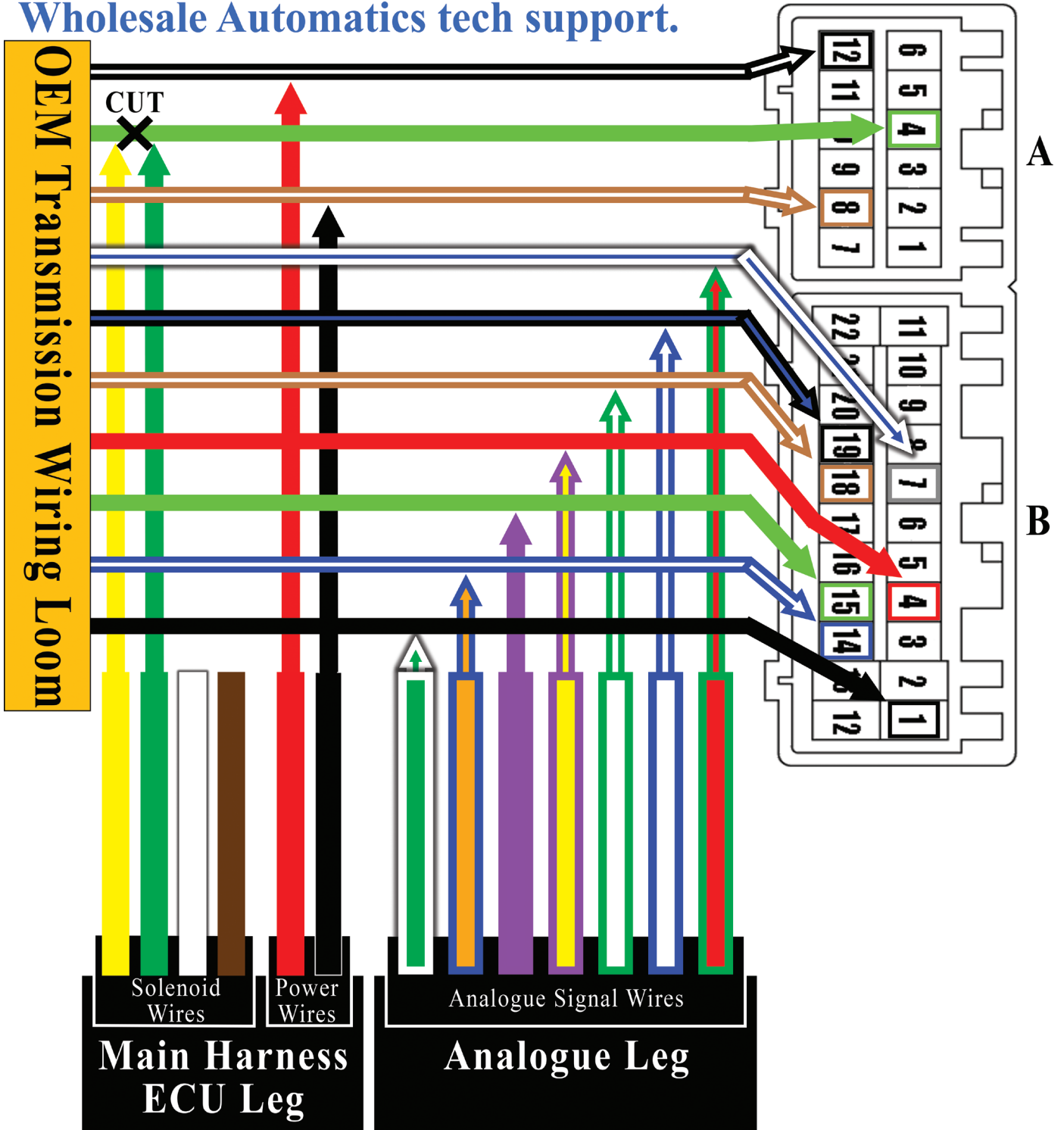

- 3.6.2 We suggest working on the ECU wiring one connector at the time. You can do these in any order, but make sure all power sources in the vehicle are disconnected before unplugging any of the connectors.
- 3.6.3 Please DO NOT use wire splicers, quick connects or scotch locks to join these wires. They MUST be soldered for reliable operation.



### 3.6.4 Soldering to Power wire in pin A12

- 3.6.4.1 Select the OEM wire in pin A12. Remove approximately 1cm of the wire sheath to expose the copper conductors about 5cm away from the connector. DO NOT cut this wire.
- 3.6.4.2 In the Power Wires group, locate the Red wire and solder this wire to the OEM wire in pin A12.
- 3.6.4.3 Use electrical tape to insulate the join and prevent shorting.

### 3.6.5 Soldering to Ground wire in pin A8

- 3.6.5.1 Select the OEM wire in pin A8. Remove approximately 1cm of the wire sheath to expose the copper conductors about 5cm away from the connector. DO NOT cut this wire.
- 3.6.5.2 Select the Black wire from the Power Wires group. Solder this wire to the OEM wire in pin A8.
- 3.6.5.3 Use electrical tape to insulate the join and prevent shorting.

### 3.6.6 Soldering to Solenoid Wire in A4

- 3.6.6.1 Select the OEM wire in pin A4 and cut it approximately 5cm from the connector. Strip about 1cm of insulation from each wire to expose the copper.



- 3.6.6.2 Locate the Green wire in the Solenoid Wires group and slide one (1) piece of 2mm black heat shrink onto the wire. Solder the Green wire to the TCM side of the OEM cut wire in pin A4. Slide the heat shrink over the join and use a heat source to shrink it.
- 3.6.6.3 Locate the Yellow wire in the Solenoid Wires group slide one (1) piece of 2mm black heat shrink onto the wire. Solder the Yellow wire to the transmission side of the OEM cut wire in pin A4. Slide the heat shrink over the join and use a heat source to shrink it.
- 3.6.7 Soldering to Signal wire in pin B19**
  - 3.6.7.1 Select the OEM wire in pin B19. Remove approximately 1cm of the wire sheath to expose the copper conductors about 5cm away from the connector. DO NOT cut this wire.
  - 3.6.7.2 Select the Blue-White wire from the Nomad Analogue Interface Loom. Solder this wire to the OEM wire in pin B19.
  - 3.6.7.3 Use electrical tape to insulate the join and prevent shorting.
- 3.6.8 Soldering to Signal wire in pin B18**
  - 3.6.8.1 Select the OEM wire in pin B18. Remove approximately 1cm of the wire sheath to expose the copper conductors about 5cm away from the connector. DO NOT cut this wire.
  - 3.6.8.2 Select the Green-White wire from the Nomad Analogue Interface Loom. Solder this wire to the OEM wire in pin B18.
  - 3.6.8.3 Use electrical tape to insulate the join and prevent shorting.
- 3.6.9 Soldering to Signal wire in pin B15**
  - 3.6.9.1 Select the OEM wire in pin B15. Remove approximately 1cm of the wire sheath to expose the copper conductors about 5cm away from the connector. DO NOT cut this wire.
  - 3.6.9.2 Select the Violet wire from the Nomad Analogue Interface Loom. Solder this wire to the OEM wire in pin B15.
  - 3.6.9.3 Use electrical tape to insulate the join and prevent shorting.

### 3.6.10 Soldering to Signal wire in pin B14

- 3.6.10.1 Select the OEM wire in pin B14. Remove approximately 1cm of the wire sheath to expose the copper conductors about 5cm away from the connector. DO NOT cut this wire.
- 3.6.10.2 Select the Blue-Orange wire from the Nomad Analogue Interface Loom. Solder this wire to the OEM wire in pin B14.
- 3.6.10.3 Use electrical tape to insulate the join and prevent shorting.

### 3.6.11 Soldering to Signal wire in pin B7

- 3.6.11.1 Select the OEM wire in pin B7. Remove approximately 1cm of the wire sheath to expose the copper conductors about 5cm away from the connector. DO NOT cut this wire.
- 3.6.11.2 Select the Green-Red wire from the Nomad Analogue Interface Loom. Solder this wire to the OEM wire in pin B7.
- 3.6.11.3 Use electrical tape to insulate the join and prevent shorting.

### 3.6.12 Soldering to Signal wire in pin B4

- 3.6.12.1 Select the OEM wire in pin B4. Remove approximately 1cm of the wire sheath to expose the copper conductors about 5cm away from the connector. DO NOT cut this wire.
- 3.6.12.2 Select the Violet-Yellow wire from the Nomad Analogue Interface Loom. Solder this wire to the OEM wire in pin B4.
- 3.6.12.3 Use electrical tape to insulate the join and prevent shorting.

### 3.6.13 Soldering to Signal wire in pin B1

- 3.6.13.1 Select the OEM wire in pin B1. Remove approximately 1cm of the wire sheath to expose the copper conductors about 5cm away from the connector. DO NOT cut this wire.
- 3.6.13.2 Select the White-Green wire from the Nomad Analogue Interface Loom. Solder this wire to the OEM wire in pin B1.
- 3.6.13.3 Use electrical tape to insulate the join and prevent shorting.

- 3.6.14 Reinstall all connectors into the TCM. Use electrical tape and the included cable ties to secure the Nomad wiring to the TCM wiring harness.

## 3.7. Mounting Nomad Module and Resistor

The Nomad module is water resistant, but we do recommend mounting it in the cabin to ensure a strong Bluetooth connection. The resistor simply needs to be mounted to something metal to help it dissipate the heat it generates during operation. If you can't locate a more suitable location a good place we have found for mounting the Nomad module and resistor is under the trim surrounding the shifter assembly.

- 3.7.1 Unscrew the knob from the top of the transfer case shifter.
- 3.7.2 The trim piece is held in with clips around its outer edge, as well as an electrical connector for the PWR/2nd Start switch and any other switches installed in this trim piece. The storage box in front of the arm rest is connected to this trim piece.

Use plastic trim removal tools to gently pry up the trim piece by the outer edge. Make sure the vehicle can't roll as the shifter may need to be moved to the neutral position, and the transfer case shifter in the low range position, in order to remove the trim piece. Disconnect the connector for the PWR/2nd Start switch, as well as any other switches installed in the trim piece, before removing the trim piece.

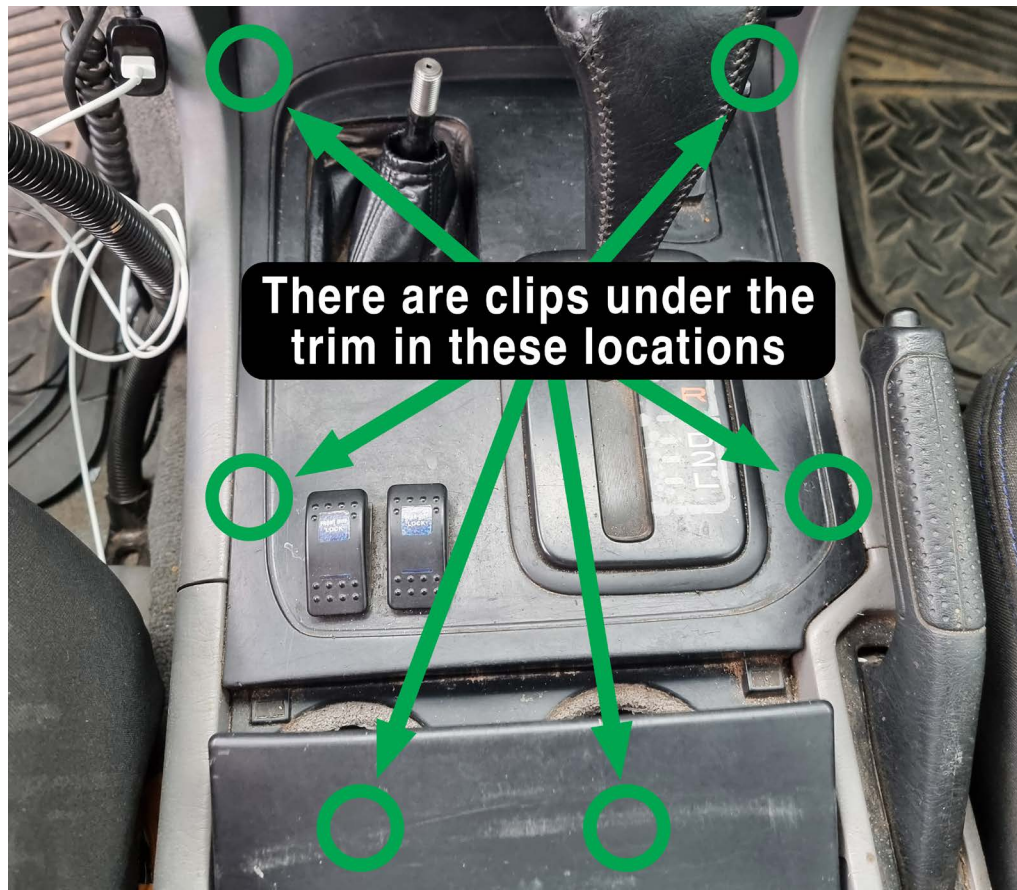

- 3.7.3 Feed the Nomad harness and Analogue Interface Loom under the dash and into the space around the shifter assembly.
- 3.7.4 Secure the resistor to a flat piece of metal using the two short self tapping screws provided. Make sure there is clearance around the resistor to prevent it from damaging any of the surrounding mechanisms.
- 3.7.5 Mount the Nomad module to a flat section under this trim piece. Ensure there is adequate clearance between it and the load resistor to prevent it from being affected by the hot resistor. Secure with the two long self tapping screws provided.
- 3.7.6 Plug the resistor into the resistor leg of the Nomad harness and secure the red Connector Position Assurance (CPA).
- 3.7.7 Plug the Nomad Analogue Interface Loom into the Vehicle leg of the Nomad harness and secure the red CPA.
- 3.7.8 Plug the main connector of the Nomad harness into the Nomad module and secure the red CPA.
- 3.7.9 Route the Switch leg of the Nomad harness to your chosen switch location.

## **3.8. Installing the Harness in the Cabin - OEM Switch**

- 3.8.1 There are a few different locations the OEM switch can be mounted, including next to the steering wheel or near the shifter. Plug in the Nomad OEM Switch Loom Adapter into the Switch leg of the Nomad harness and route this leg of the harness to your chosen switch location. We chose to mount the switch near the steering wheel for easy access while driving.

You can choose a switch with either horizontal or vertical text when you purchase your Nomad Lock-Up kit, depending on where you are wanting to install the switch.

- 3.8.2 Remove the necessary trim pieces to gain access to the rear of your chosen switch location.
- 3.8.3 Remove a switch blanking plate from your chosen switch location and replace it with the new OEM-style TCC switch.
- 3.8.4 Plug the Green OEM-style switch connector into the TCC switch and then reinstall any trim pieces removed for the installation of your switch.

### **3.9. Final Tidy Up**

- 3.9.1 Secure any loose wires with electrical tape and any remaining supplied cable ties. Make sure the wires are clear of any moving parts, especially near the steering column.
- 3.9.2 Reconnect the battery terminals and any other connectors that were removed.
- 3.9.3 We recommend running through the Nomad Setup Wizard to verify that everything is connected correctly and working properly before re-installing any panels, unless they impede the test driving process, just in case any wiring needs to be corrected.
- 3.9.4 Once the Nomad module has been confirmed to be wired correctly and the setup wizard has completed, reinstall all removed trim pieces and kick panels.

We do not recommend driving the vehicle before the setup wizard is complete.

### 3.10. Lock-Up Module Bypass

3.10.1 If you need to remove the Nomad Lock-Up Module at any stage we have supplied a bypass connector that can take the place of the module so that your vehicle will not have faults come up while driving. Fitting this bypass will revert control of the torque converter clutch back to the OEM TCM.

If you are fitting this unit on behalf of a customer please leave this connector in the bag along with the QR code to access the User Guide. Please highlight this to your customer during handover.



3.10.2 To remove the Nomad Lock-Up Module or Bypass Connector, unlock the red CPA. Press down on the black clip to release. Then pull the two connectors apart.

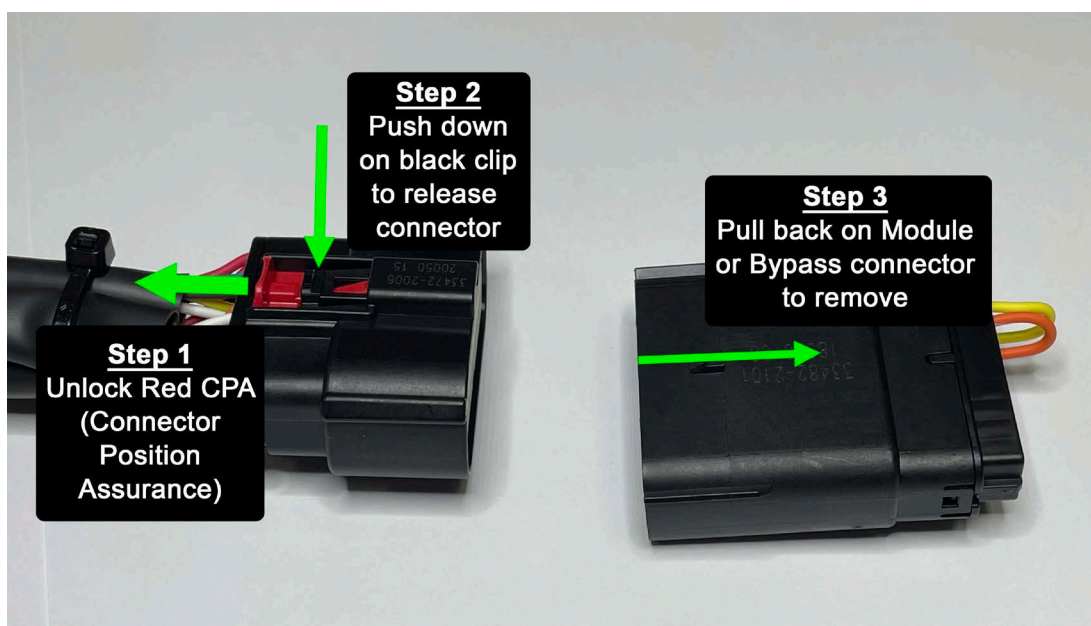

## 3.11. Installing the Nomad LockUp app on Apple Devices

This chapter will cover finding, downloading and confirming that the Nomad LockUp app is ready to communicate with your Nomad LockUp Module using an Apple mobile device.

The Nomad Lock-Up App is a free to download app available from the Apple App Store. You will require an Apple ID in order to download applications from the Apple App Store.

Minimum system requirements for your Apple mobile device to run the Nomad LockUp App are:

- Apple iPhone mobile digital device with iOS version 11 or later
- Apple iPad mobile digital device with iPadOS version 11 or later
- Internet Access (only required to download the application and for firmware updates)

If your Apple mobile device operating system does not meet these requirements you may not be able to download the app. Please follow the instructions provided by Apple to update your devices operating system first then try downloading the Nomad LockUp app again.

### 3.11.1 On your Apple device, open the **App Store** application.



### 3.11.2 Tap on the **Search** button at the bottom of the App Store screen.

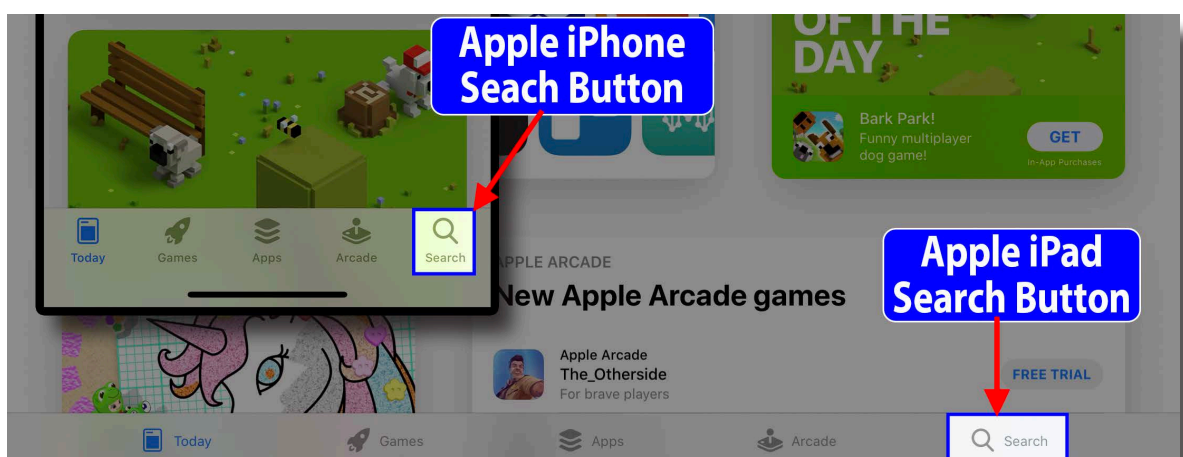

3.11.3 In the search field type “nomad lockup” and press enter/search. Locate the app called **Nomad LockUp** in the results and tap on ‘Get’. You may be asked to enter your Apple ID username and password.

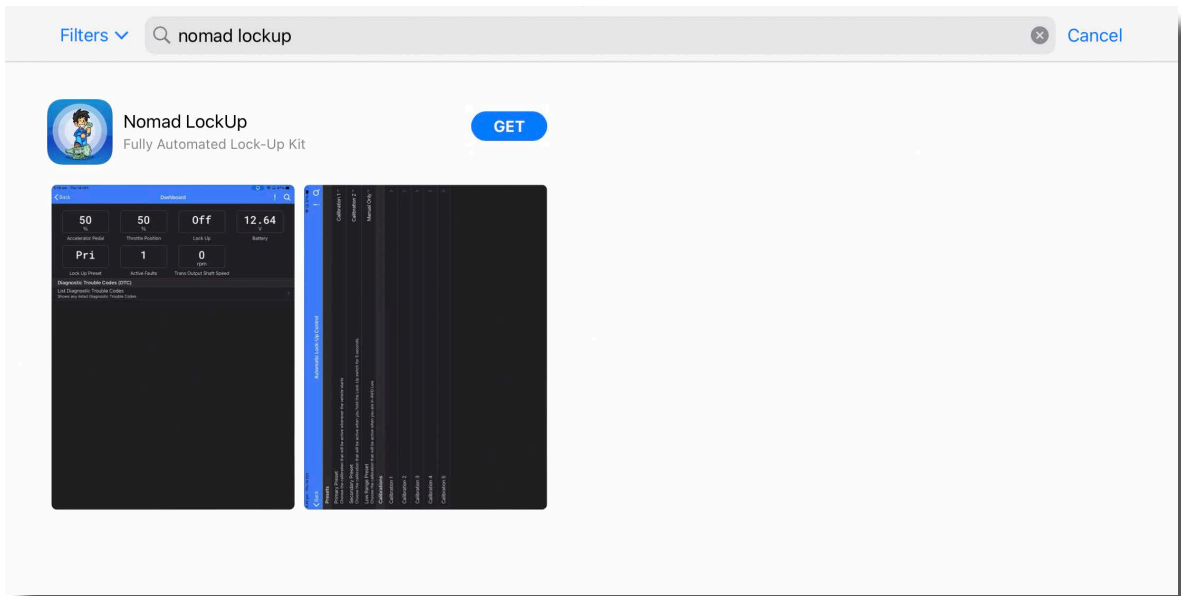

3.11.4 Once the app has finished downloading, tap on the icon to open. The first time you open the Nomad LockUp app it will ask permission to use the devices Bluetooth® communication system to access the Nomad Lock-Up Module. Please select OK.

3.11.5 The app will now search for any Nomad Lock-Up Modules within range that are powered up. If you are not in range of your Nomad Lock-Up Module or it is not powered up, then the app will only show a spinning wheel indicating that there is no module in range.

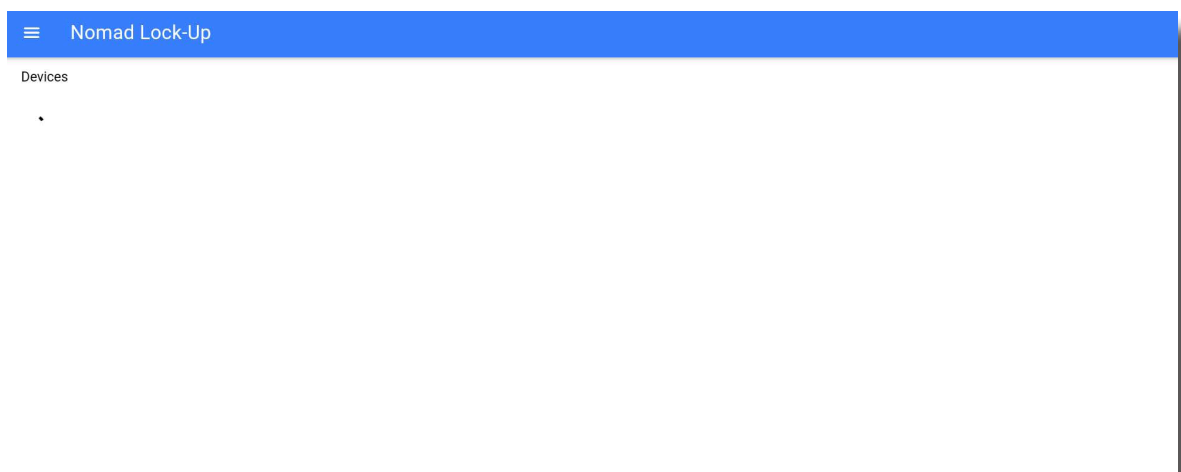

3.11.6 If you have reached this step then the app is installed and ready to connect to your Nomad Lock-Up Module. You can now skip to step 4.



## 3.12. Troubleshooting Installation on Apple Devices

This chapter will cover some basic troubleshooting steps you can follow if you have not been able to connect your Apple device to the Nomad Lock-Up module.

3.12.1 If the app says '**! Bluetooth is disabled**' then it means that the Bluetooth communication in your smart device is not set up correctly. Most commonly this is due to the Bluetooth being turned off completely or it could be that the Nomad LockUp app has not been authorised to use Bluetooth yet.

3.12.2 First, close the app down and then quit the app by swiping up from the bottom or double pressing the home button and then swipe up on the app. Re-open the app. If the '**! Bluetooth is disabled**' message still remains continue to the next step.

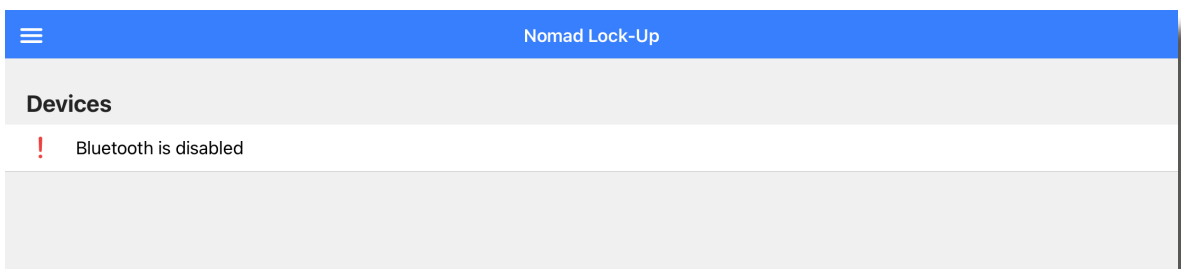

3.12.3 Open the Settings app and select Bluetooth. If Bluetooth is switched off, please turn it on. Close the settings app and re-open the Nomad LockUp app. You should no longer see the '**! Bluetooth is disabled**' message, instead it should be replaced with the spinning wheel.

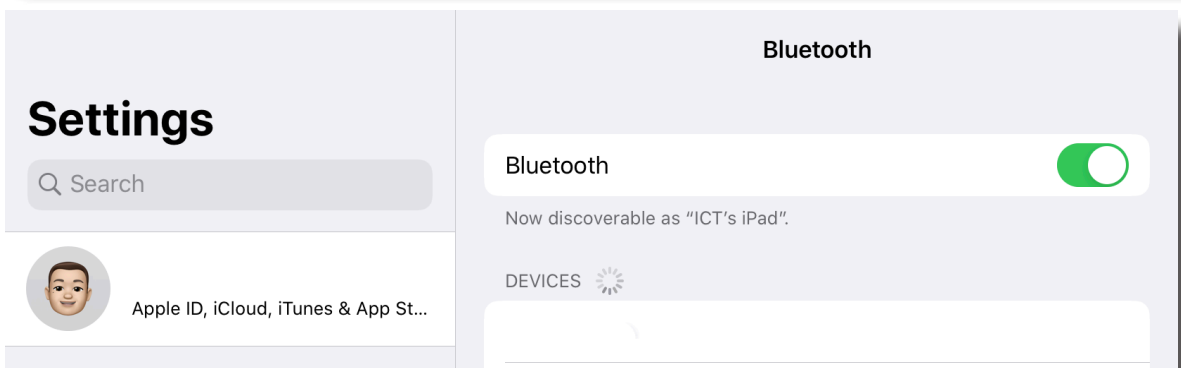
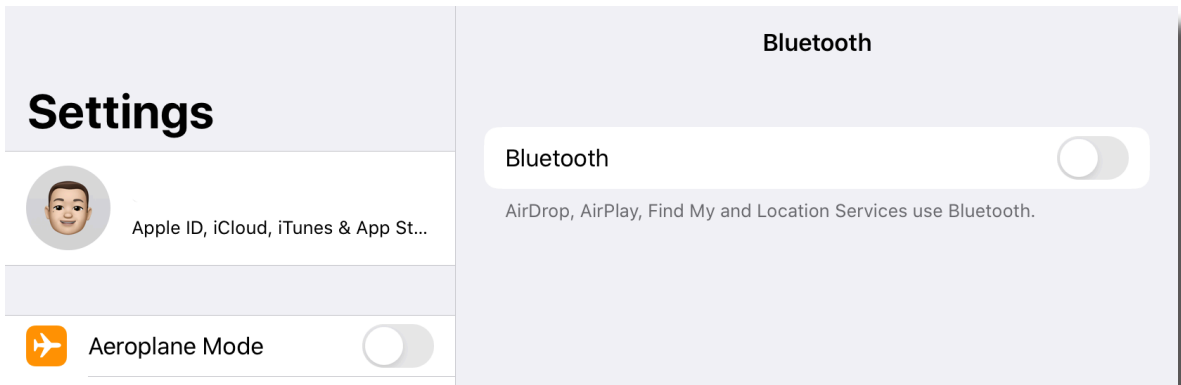

3.12.4 If you are still seeing the '**! Bluetooth is disabled**' message, open the Settings app and scroll down the menu to Nomad LockUp. Tap on Nomad LockUp and verify that the Bluetooth access is enabled for the app. If not, switch access on. Return to the Nomad Lock-Up app and check you are no longer seeing the '**! Bluetooth is disabled**' message, instead you should be seeing the spinning wheel.

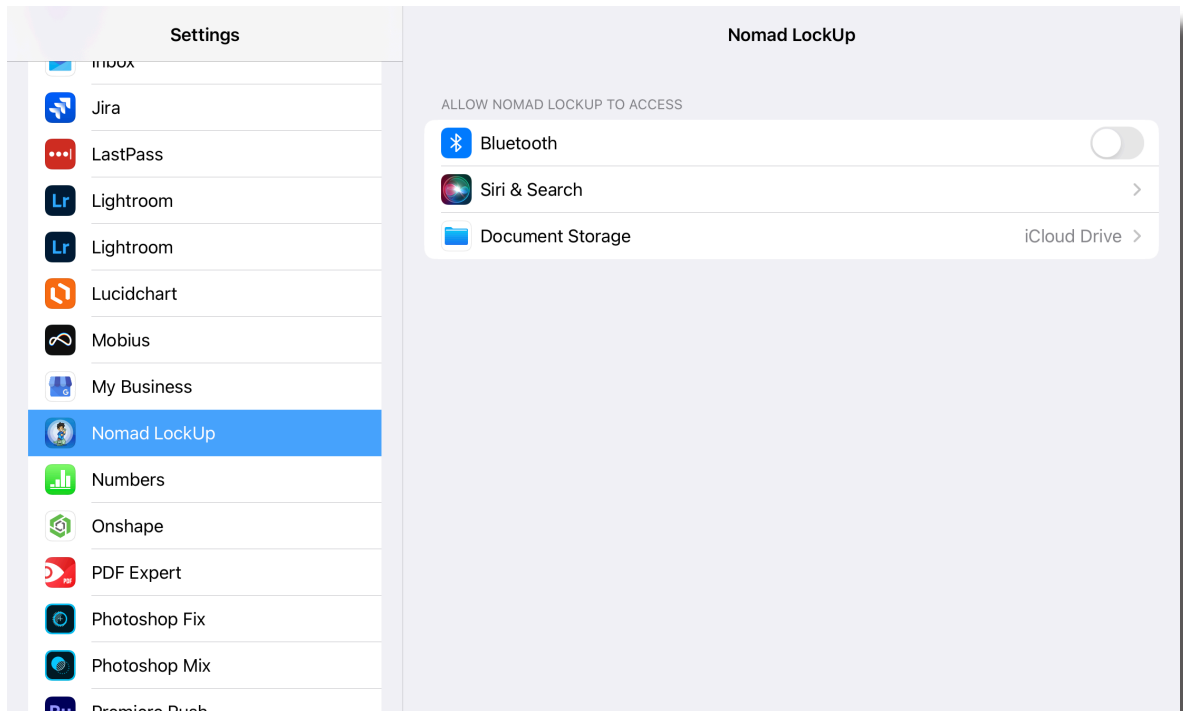

3.12.5 If none of these items have worked, please close the app. Tap and hold on the Nomad Lock-Up app icon and select Delete app. Then power your device off and reboot. Start from the beginning and download the app again. Make sure you allow the app all the permissions it requests.

3.12.6 If you are still unable to get rid of the '**! Bluetooth is Disabled**' message please contact Wholesale Automatic Transmissions for further assistance.

### 3.13. Installing the Nomad LockUp app on Android™ Devices

This chapter will cover finding, downloading and confirming that the Nomad LockUp app is ready to communicate with your Nomad Lock-Up Module using an Android mobile device.

The Nomad LockUp app is a free to download app available from the Google Play Store. You will require a Google Account in order to download applications from the Google Play Store.

Minimum system requirements for your Android mobile device to run the Nomad LockUp app are:

- Android operating system version 4.4 or later
- Internet access (only required to download the application and for firmware updates)

If your Android mobile device operating system does not meet these requirements you may not be able to download the app. Please follow the instructions provided by your device manufacturer to update your devices operating system first then try downloading the Nomad LockUp app again.

If the operating system on your Android mobile device is unable to be updated to a compatible version you will need to locate an alternative smart device that does meet the requirements.

- 3.13.1 On your Android device, open the **Google Play Store** application. Tap on the **Search** field at the top of the Google Play Store screen and type “nomad lockup”. Tap on the Nomad LockUp app to show the app page.

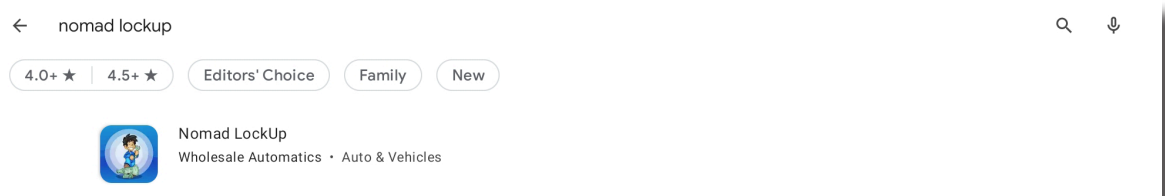

- 3.13.2 On the app page, tap on Install to download and install the app.

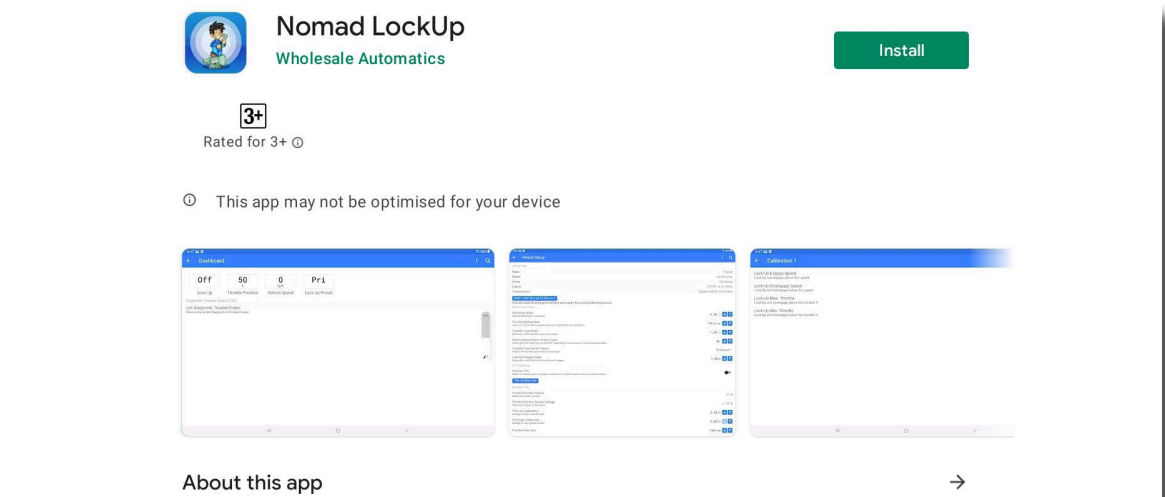

3.13.3 When the app opens for the first time you will be asked for permission for the app to access the devices location. Tap on 'While using the app' to continue. This permission is required for the Bluetooth functionality.

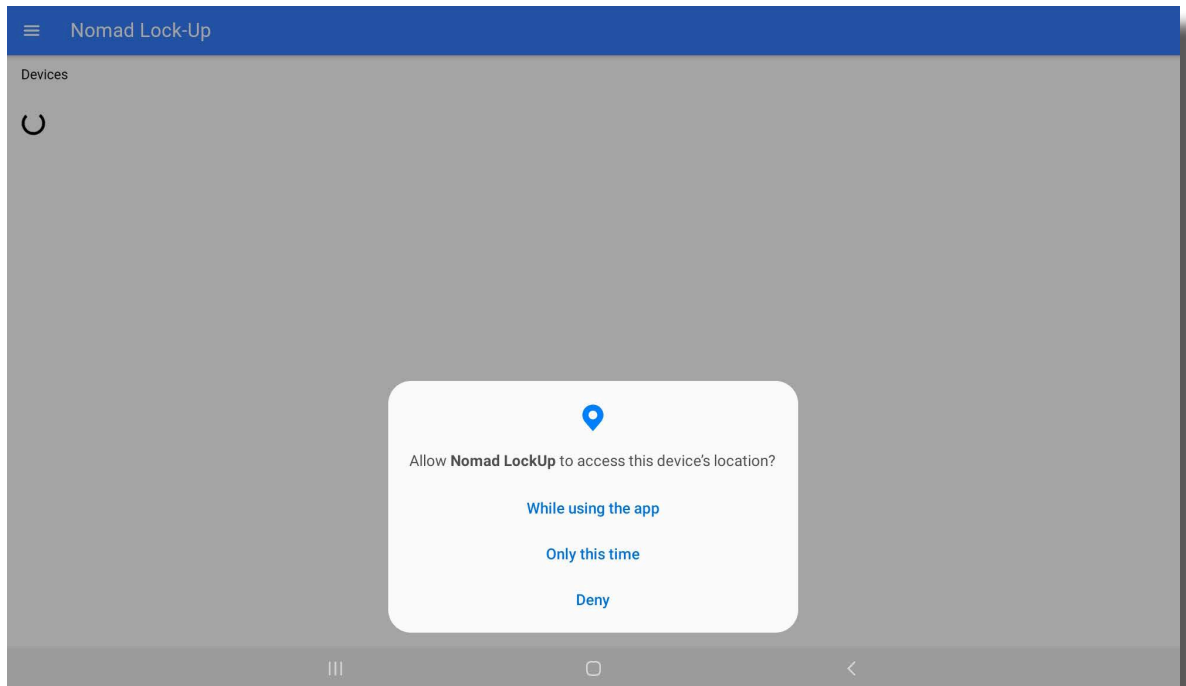

3.13.4 You should now see the devices page and a list of any Nomad Lock-Up Modules that are powered up and within range. If you are not in range of your Nomad Lock-Up Module or it is not powered up then the app will only show a spinning wheel indicating that there is no module in range.

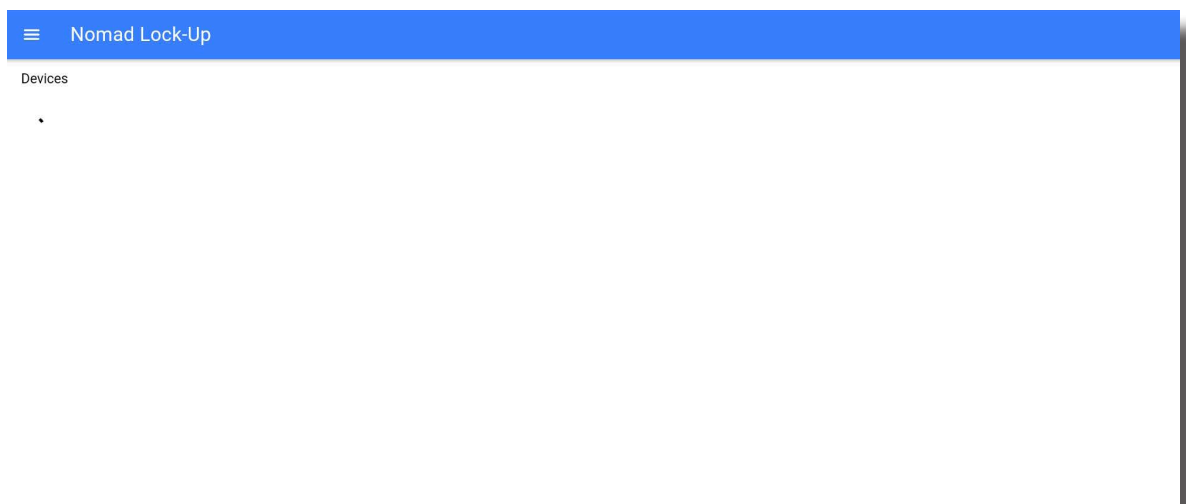

3.13.5 If you have reached this step the app is installed and ready to connect to your Nomad Lock-Up Module. You can now skip to step 4.

## 3.14. Troubleshooting Installation on Android Devices

This chapter will cover some basic troubleshooting steps you can follow if you have not been able to connect your Android device to the Nomad Lock-Up module.

3.14.1 If the app says '**! Bluetooth is Disabled**' then it means that the Bluetooth communication in your smart device is not set up correctly. This could be because your app did not recognise that it has access to your Bluetooth system, Bluetooth is turned off completely or it could be that the Nomad LockUp app does not have the required Bluetooth permissions.

3.14.2 First, close the app and close it from the multitasking menu. Re-open the app. If the '**! Bluetooth is Disabled**' message still remains continue to the next step.

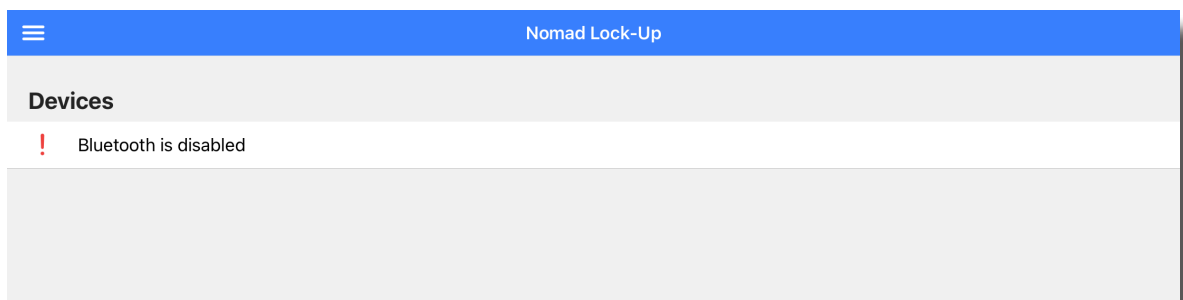

3.14.3 Swipe down from the top of the screen and tap on the grayed out Bluetooth icon. Close the settings window and force close the Nomad LockUp App. Re-open the Nomad LockUp app, you should no longer see the '**! Bluetooth is disabled**' message, instead it should be replaced with the spinning wheel.

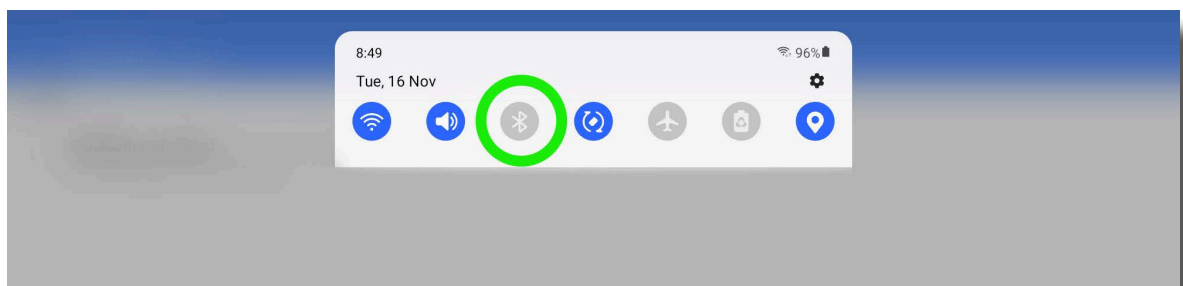

3.14.4 If you are seeing the '**Location services are disabled**' message, this means that you have locations service switch off. This service is required for the app to function correctly.

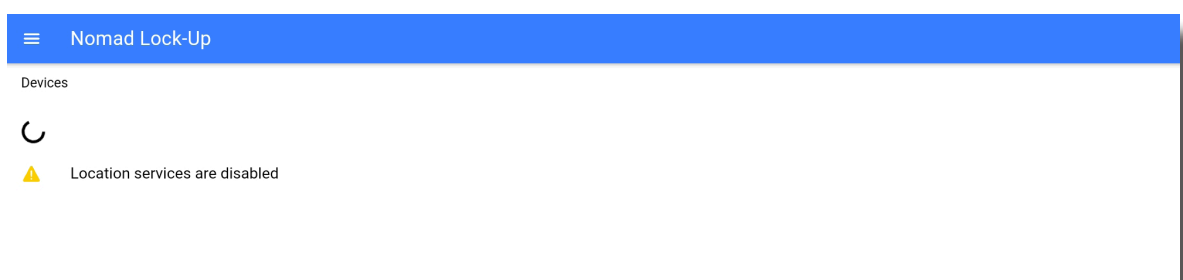

- 3.14.5 Swipe down from the top of the screen and tap on the grayed out locations icon. This will turn locations service on. Close the settings window and force close the Nomad LockUp app. Re-open the Nomad LockUp app, you should no longer see the '**Location services are disabled**' message. It instead should be replaced with the spinning wheel.

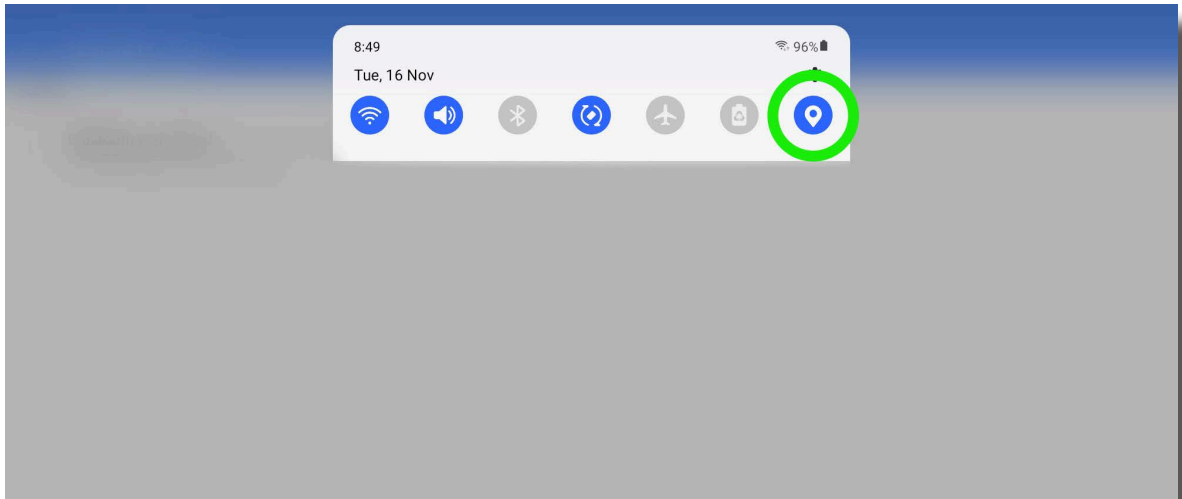

- 3.14.6 If none of these items have worked, please close the app. Tap and hold on the Nomad LockUp app icon and tap on Uninstall. Then power your device off and reboot. Start from the beginning and download the app again.
- 3.14.7 If you are still seeing the '**! Bluetooth is disabled**' message or the '**Location services are disabled**' message please contact Wholesale Automatic Transmissions for further assistance.

## 4. Setup Wizard

### 4.1. First Connection and Firmware Update

- 4.1.1 Turn your vehicle's ignition on, but do not start the engine.
- 4.1.2 Open the Nomad Lock-Up application
- 4.1.3 Tap on your Nomad Lock-Up module from the Devices list.

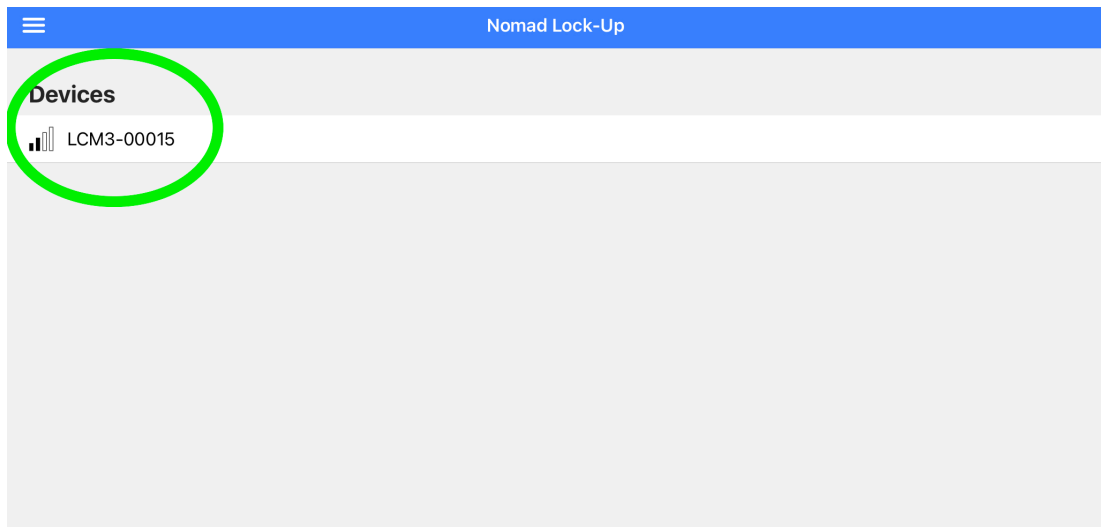

- 4.1.4 If this is the first time you have connected to your Nomad module you will be prompted to pair your device. Tap Pair.

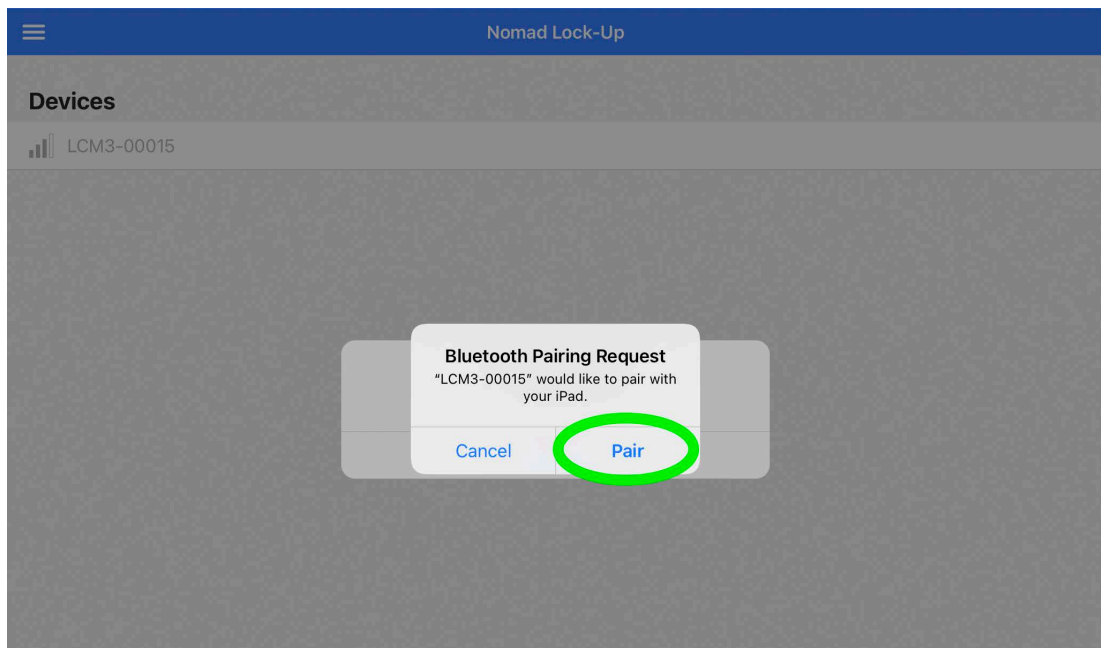

- 4.1.5 Upon initial connection the Nomad LockUp app will check if there is a new version of firmware for the module. As we develop new vehicles and add features we will provide the ability to update firmware as needed.

You will see the following prompt if there is new firmware available for your Nomad module. If your Nomad Lock-Up module is running the latest firmware, you can skip to the vehicle setup step.

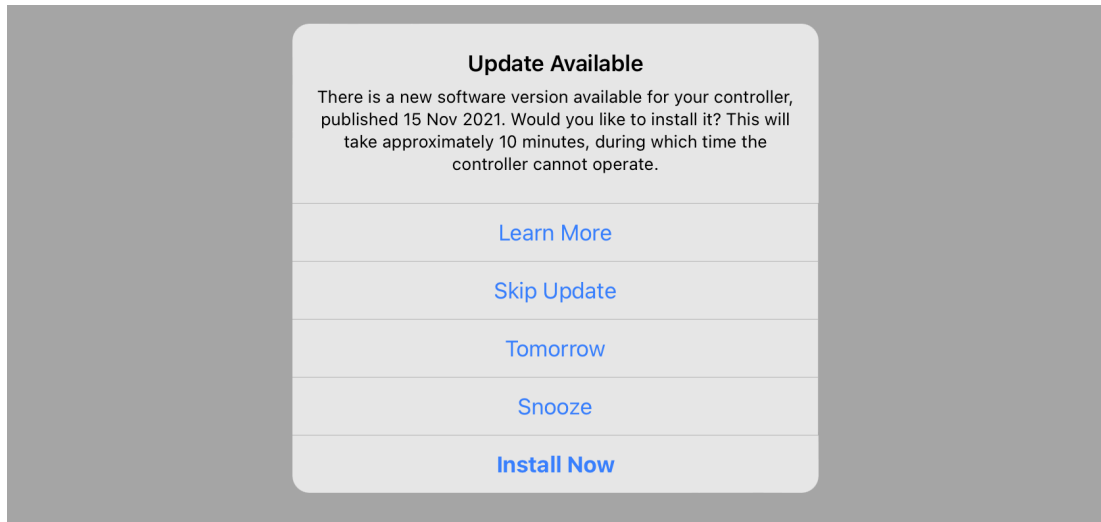

- 4.1.6 Tap on Install Now. This will take approximately 10mins to download and install the latest firmware to ensure your Nomad Lock-Up module is up to date.
- 4.1.7 Please ensure your device does not go to sleep during this process. Also if you are using a phone do not answer a call during this process as it may cause the update to fail.

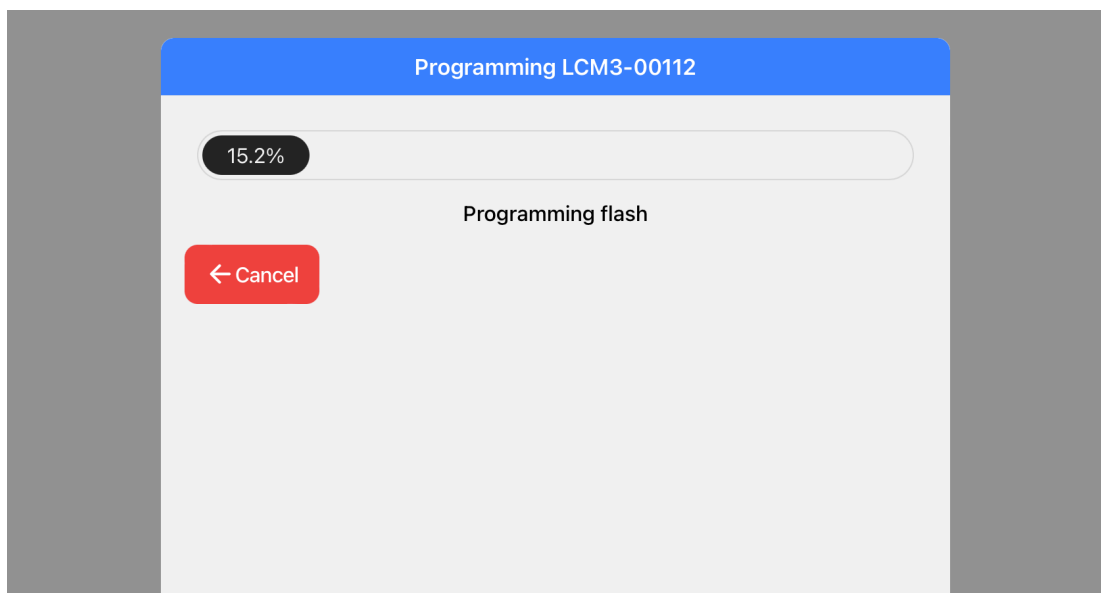

- 4.1.8 Once your modules firmware has been updated you will be returned to the devices page. Tap on your device once more to connect.



## 4.2. Vehicle Configuration

- 4.2.1 The Setup Wizard will ask you to select your vehicle configuration. In some cases we may prefill the following values due to them being the only option.

Select “Apply Changes and Restart” to continue.

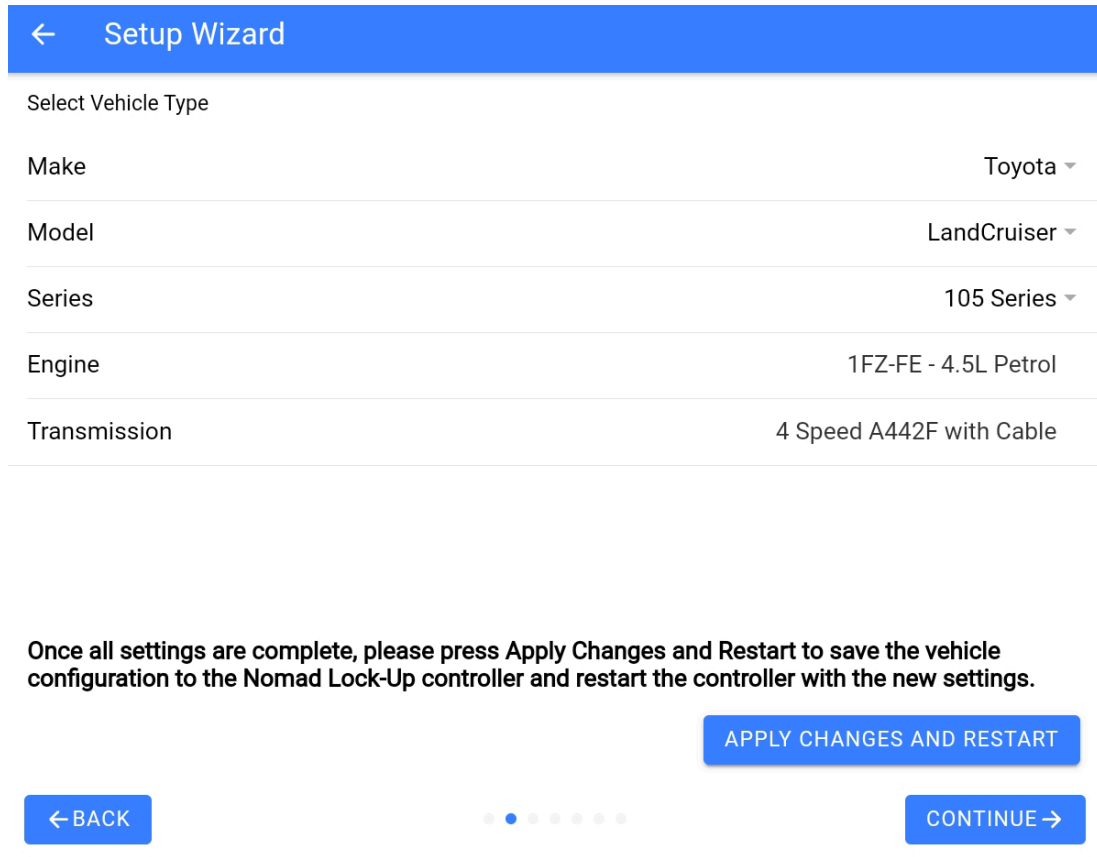

The screenshot shows the 'Setup Wizard' screen with a blue header bar containing a back arrow and the text 'Setup Wizard'. Below the header, the text 'Select Vehicle Type' is displayed. The configuration is as follows:

Make	Toyota ▾
Model	LandCruiser ▾
Series	105 Series ▾
Engine	1FZ-FE - 4.5L Petrol
Transmission	4 Speed A442F with Cable

Below the configuration table, the text reads: "Once all settings are complete, please press Apply Changes and Restart to save the vehicle configuration to the Nomad Lock-Up controller and restart the controller with the new settings." At the bottom of the screen, there are three buttons: a blue '← BACK' button on the left, a blue 'APPLY CHANGES AND RESTART' button in the center, and a blue 'CONTINUE →' button on the right. A progress indicator with five dots is located between the 'BACK' and 'CONTINUE' buttons, with the first dot filled.

- 4.2.2 Wait while the Nomad Lock-Up Module restarts.

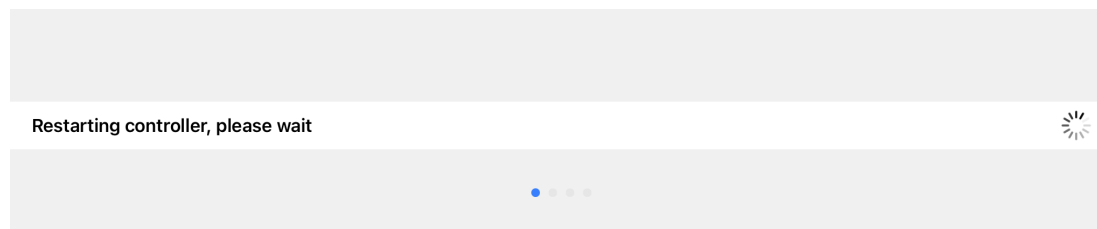

The screenshot shows a screen with a grey background and a white bar at the top containing the text 'Restarting controller, please wait' and a loading spinner icon on the right. Below the white bar, there are five dots in a row, with the first dot filled, indicating the progress of the restart process.

- 4.2.3 After the Nomad Lock-Up Module has rebooted tap “Continue”.

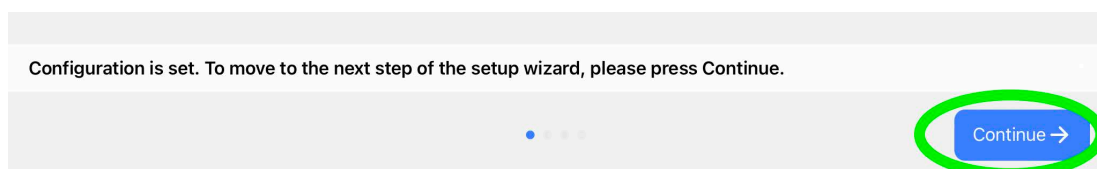

The screenshot shows a screen with a grey background and a white bar at the top containing the text 'Configuration is set. To move to the next step of the setup wizard, please press Continue.' Below the white bar, there are five dots in a row, with the first dot filled. At the bottom right of the screen, there is a blue 'Continue →' button, which is circled in green.

- 4.2.4 Checking Sensor Inputs allows you to verify that the signals the Nomad Lock-Up module requires to operate are being decoded correctly. Test these signals with the engine off.

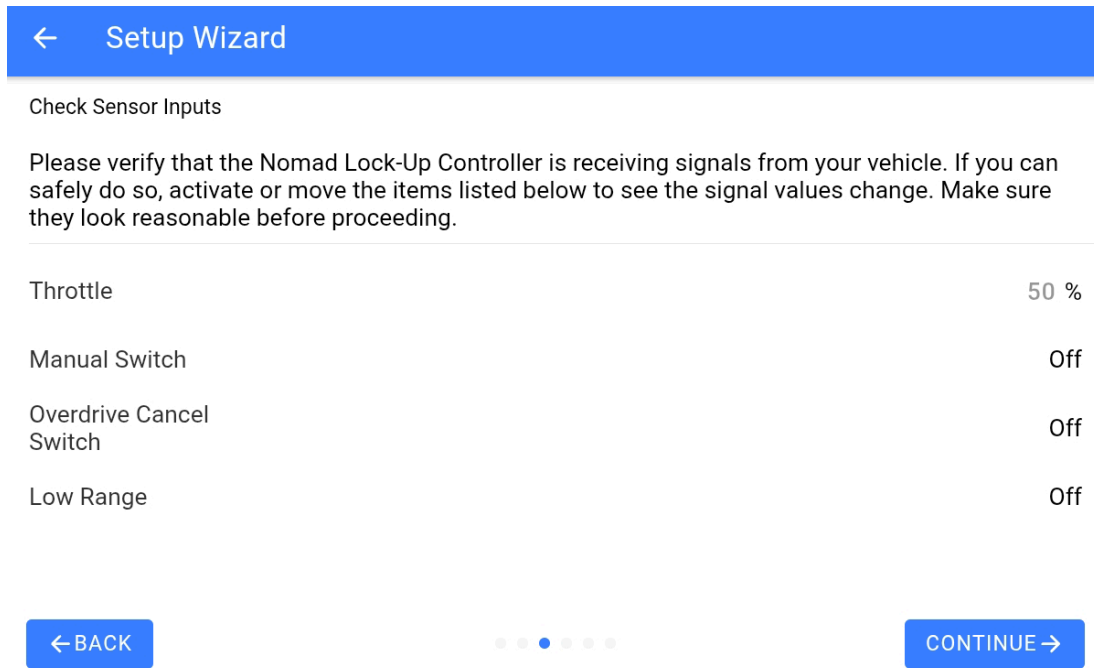

- 4.2.4.1 **Throttle**  
This value won't be correct until the Throttle Position Sensor calibration is completed in a later step.
- 4.2.4.2 **Manual Switch**  
Push the Lock-Up switch to check that the Manual Switch value will change from "Off" to "On".
- 4.2.4.3 **Overdrive Cancel Switch**  
Check that the Module can detect when the overdrive cancel switch is pressed.
- 4.2.4.4 **Low Range**  
Move the transfer case lever into the low range position to check that the Low Range value changes from 'Off' to 'On'.
- 4.2.5 Once all signals are confirmed, tap "Continue".
- 4.2.6 Choose if you would like the Nomad Lock-Up Module to operate in Automatic or Manual Mode. Then tap continue.

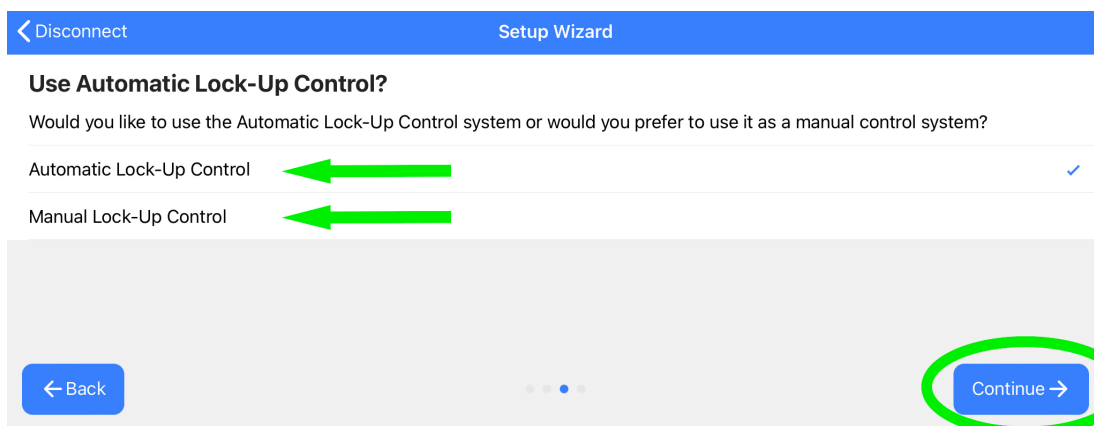

#### 4.2.6.1 Automatic mode

The torque converter lock-up will automatically engage and disengage at predetermined speeds and loads that we have configured for you. These values can be modified at anytime to suit your driving style. In Low Range the lock-up is still controlled manually via the switch.

**This is the recommended setting for most people.**

For more information about configuring the Nomad Lock-Up system, please check out our Nomad Lock-Up Users Guide. Link below.



#### 4.2.6.2 Manual mode

You decide when the lock-up is engaged by toggling lock-up on and off via the manual switch. This will make the Nomad Lock-Up Module operate the same way as our previous GEN2 Lock-Up Kit.

- 4.2.7 Please set the Rolling Tire Diameter for your vehicle. To find the Rolling Diameter measure from the ground to the centre of the axle, then double this measurement and enter it into the app.

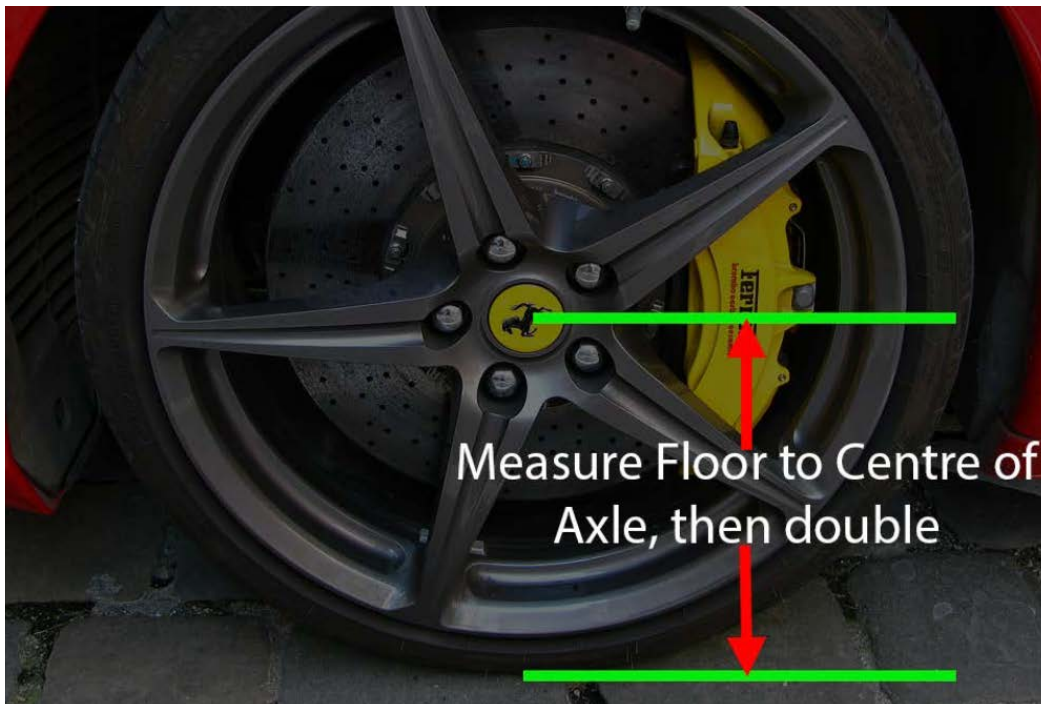
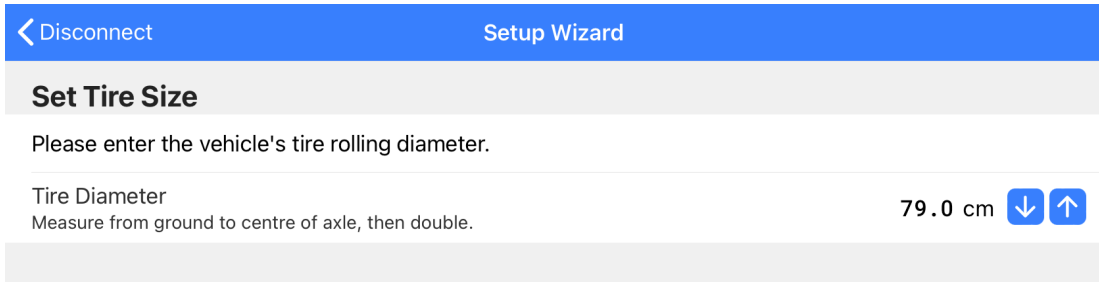

- 4.2.8 Tap "Finish" to complete the Setup Wizard

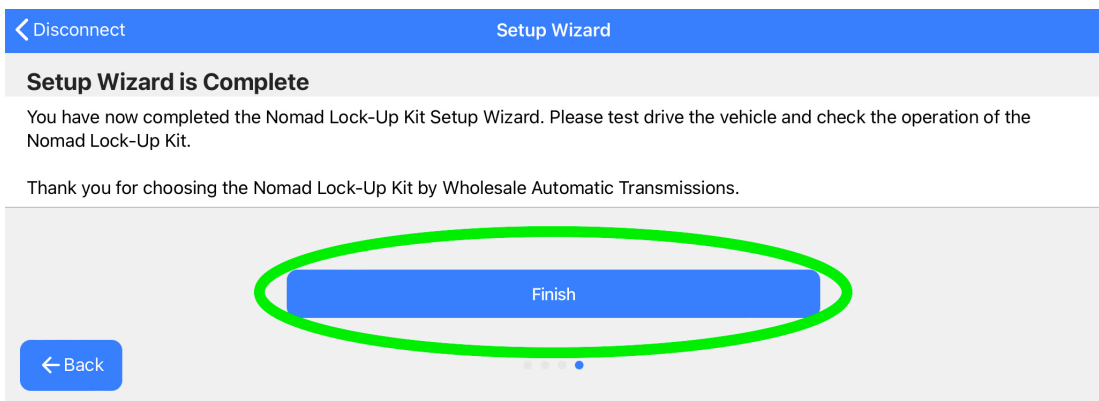

- 4.2.9 Turn your ignition off and then back on again to power cycle the Nomad module.

### 4.3. Throttle Position Sensor Calibration

- 4.3.1 Once you reconnect to your module you will likely have a couple of trouble codes related to the Throttle Position Sensor (TPS). You will need to perform a TPS calibration in order for the Nomad module to function correctly.
- 4.3.2 Ensure the engine is not running but the ignition is switched on. Navigate to the Vehicle Setup page and tap on TPS Calibration.

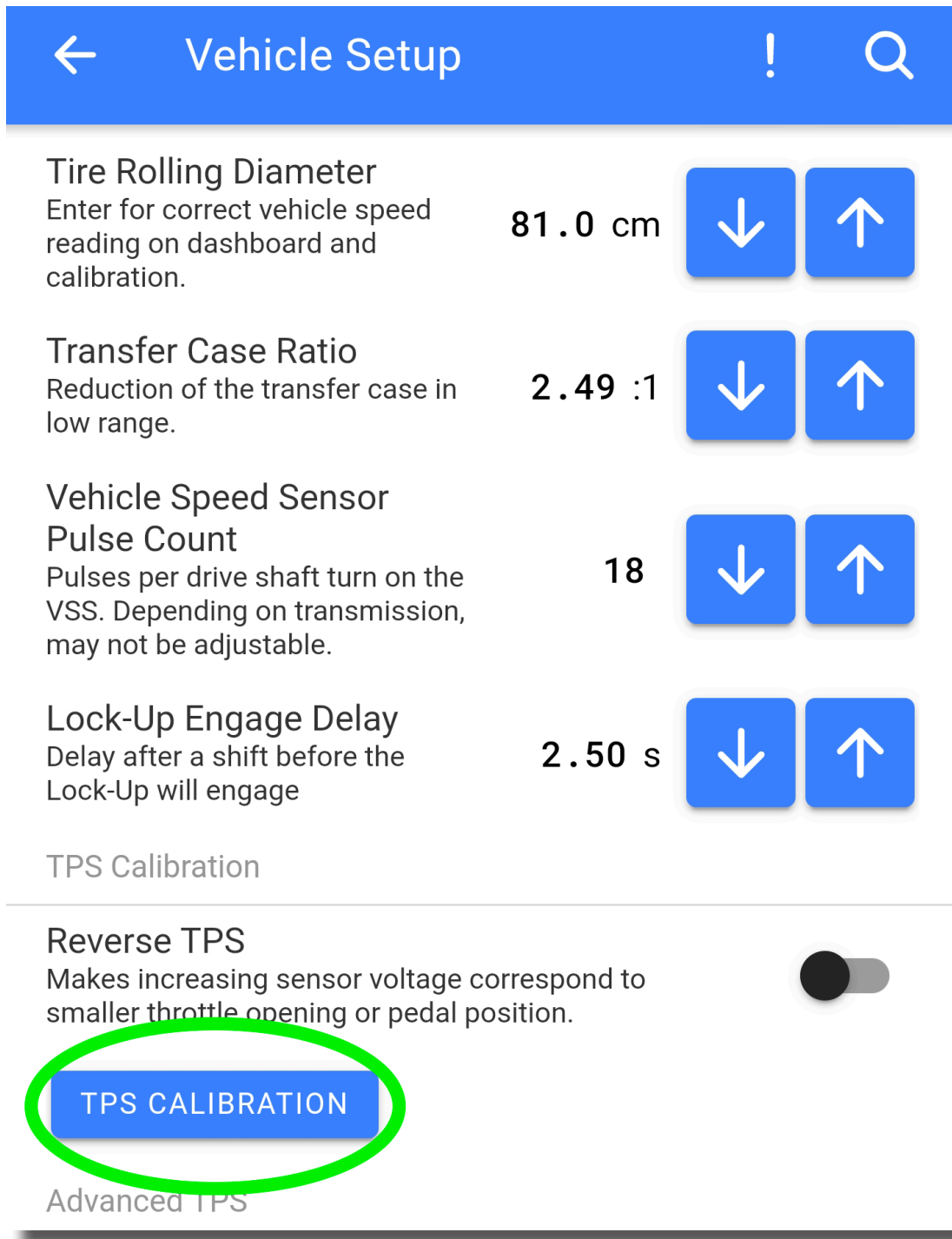

- 4.3.3 With your foot off the throttle pedal, tap Start. You will have 5 seconds to press the throttle pedal as hard as you can to the floor, then release it completely. Try and do this 2 or 3 times before the timer runs out.
- 4.3.4 Tap OK once the TPS calibration is complete.
- 4.3.5 Turn your ignition off and then back on again to power cycle the Nomad module.
- 4.3.6 Allow time for the app to reconnect to the Nomad Lock-Up Module. Confirm there are no DTCs (Diagnostic Trouble Codes) set. If you see the tick at the top right, you have completed the installation.

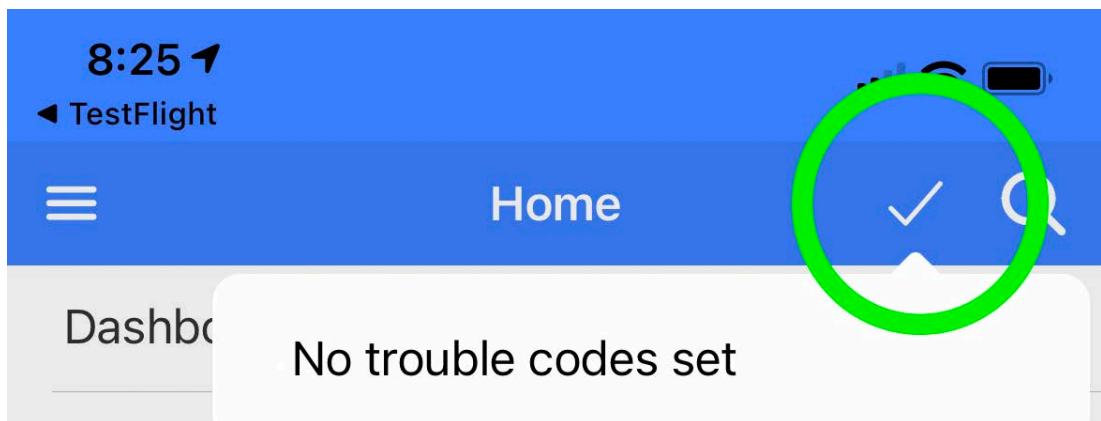

- 4.3.7 You can now take the vehicle for a test drive to confirm the Nomad Lock-Up kit is operating as expected. At this point, we recommend re-installing any dash panels or parts removed during the installation process of the Nomad Lockup Module.
- 4.3.8 After the test drive, before switching off the vehicle, connect to the Nomad Lock-Up Module with the app to confirm you still see the tick at the top right.

Apple, Apple ID, App Store, iOS and iPadOS are a trademark of Apple Inc, registered in the U.S. and other countries and regions.

Android is a trademark of Google LLC.

The Bluetooth® word mark and logos are registered trademarks owned by Bluetooth SIG, Inc, and any use of such marks by Wholesale Automatic Transmission is under license. Other trademarks and trade names are those of their respective owners.

## This completes the Installation of the Nomad Lock-Up Kit

If you would like further information  
on how to adjust all of the  
calibration settings, please see  
User Guide documentation on our  
website using the QR code below or  
tapping on the QR code.



## Please provide us with feedback

If you have a minute to provide us with some feedback about your experience with Wholesale Automatic Transmissions and our products, that would be greatly appreciated.

Using your device's camera app to scan the QR code below. This will take you straight to our feedback page for you to choose the most appropriate feedback method.

