



External Transmission Oil Cooler Kit

Suitable for:



**Isuzu D-MAX and MU-X
5 Speed A750 and 6 Speed AC60
Automatic Transmission**

**WITH THE FOLLOWING ENGINES:
4JJ1-TCX 3.0L TURBO DIESEL - 06/2012 TO PRESENT**

Please read through all of the instructions carefully before proceeding. If any of the information does not appear correct or the diagrams don't match your vehicle, please contact Wholesale Automatic Transmissions on +61 3 9762 8004.

Safety First

Hot engines and hot transmissions can cause serious injury. Before removing the hoses and parts from the vehicle, allow sufficient time for engine and auto to cool.

Parts List

Cross Flow Oil Cooler
Pre-Mounted to Bracket



4 x 8-16mm Stainless
Steel Cooler Line Screw
Clamps



2.5m x 10mm High
Temp Cooler Line Hose
with Conduit



2 x M6x20 SEMS Bolts
For Mounting Bracket



5 x 300mm Cable Ties



Expected Installation Time: 2 Hours

Summary of Installation - For Experienced Fitters

- Ensure you have enough transmission oil to top up your transmission.
- Remove the plastic cover above the radiator by removing the (4) plastic clips.
- Remove the (1) phillips head screw in the center of the grill under the Isuzu badge.
- Gently pull the grill forward and unclip it from the (2) plastic tabs. Remove the grill.
- Locate the horn, remove the 10mm head bolt, flip the horn to face the opposite direction and reattach the bolt to secure the horn.
- Locate the two 10mm bolts in the center brace of the bottom of the radiator support. Remove the (1) 10mm bolt on the passenger side.
- Under the Vehicle, Remove the three front factory bash plates.
- Locate the short OEM transmission fluid hose secured by squeeze clamps running behind the bottom of the radiator. It runs between two OEM union fittings. Remove this hose.
- Remove protective rubber socks from your new transmission cooler fittings.
- Cut the provided cooler line in half. Fit one half of the line to each side of the cooler - FIT IT DRY - DO NOT use lubricant.
- Clamp the cooler lines to the cooler unit fittings using the provided screw clamps.
- Fit the cooler bracket and hoses in front of the radiator. Fit the supplied 10mm head bolt through the top of the radiator support and into the top cooler bracket nutsert.
- Refit the 10mm head bolt that was removed from the center brace on the bottom of the radiator support through the Wholesale Automatics cooler bracket and into its OEM hole located on the passenger side of the center brace of the lower radiator support.
- Reinstall the grill assembly by reversing earlier steps.
- Route the rubber cooler lines over the front chassis support and under the radiator. Roughly route lines to the OEM unions exposed earlier by the removal of the short length of OEM transmission hose. It does not matter which line is connected to which OEM union. Cut to length.
- Connect the rubber cooler line to the OEM unions exposed earlier using provided stainless steel hose clamps. Secure lines with provided cable ties as required.
- Remove the 24mm bolt on the transmission extension housing. Top up transmission with OEM or equivalent transmission fluid. Replace 24mm head bolt.
- Road test vehicle, check for leaks and retighten any fittings as required.
- Refit bash plates by reversing earlier steps.

Detailed Installation Instructions

Before Commencing work, please ensure that you have sufficient transmission fluid to top up at the end of the job.

1. Ensure the car is fully switched off. It is recommended that the vehicle is cold prior to installation.
2. Open bonnet.
3. Remove the (4) plastic clips on top of the radiator support holding down the plastic cover.



4. Remove the (1) phillips head screw in the centre of the grill located just under the Isuzu front badge.

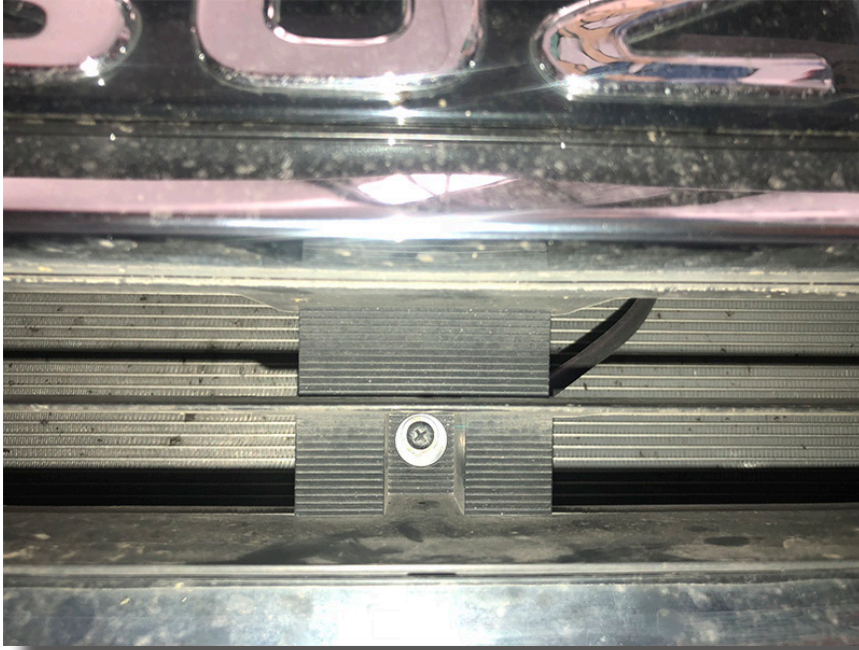

5. Lightly pull the front grill forward in order to access the two plastic tabs which hold it into the front bumper bar.

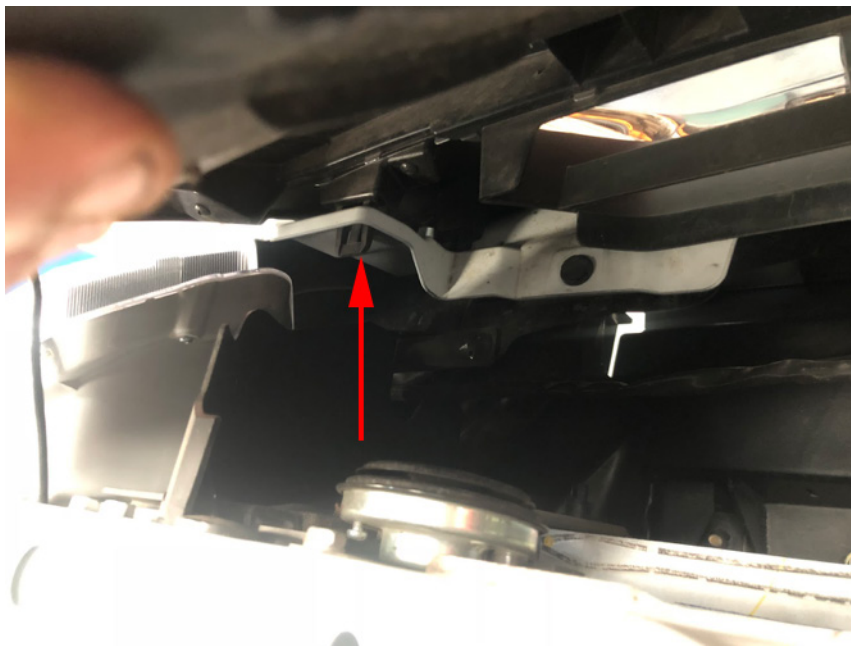

6. Gently undo the two plastic tabs by lightly lifting them up while holding forward pressure on the grill.
7. Once the two tabs have been released, gently manoeuvre the front grill assembly out by holding it forward while pulling it up. Place the grill in a safe location.



8. Flip the horn around and refit the (1) 10mm bolt to secure the horn. (Refer to below photos).

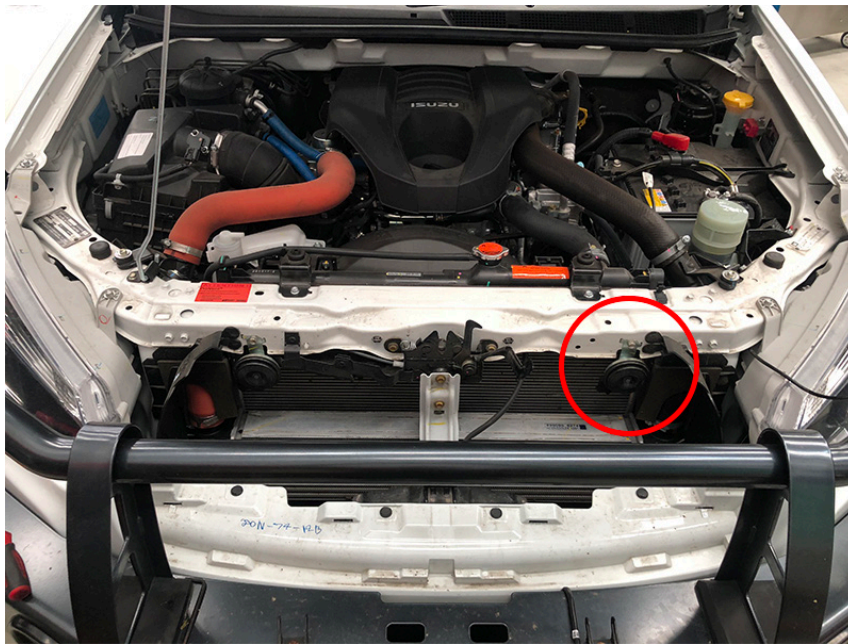

Original position of the horn:

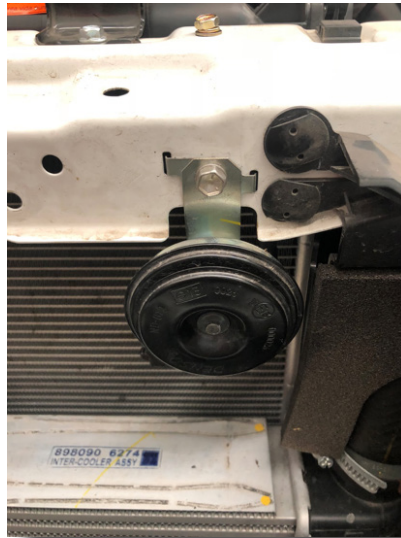

New position of the horn:



9. Remove the (1) 10mm bolt located in the centre brace of the bottom radiator support on the passenger side of the vehicle.

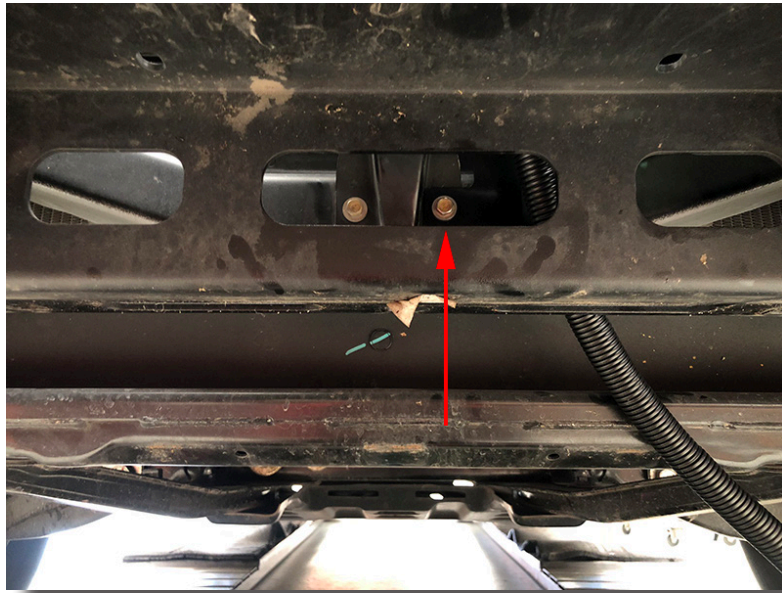

10. Under the front of the car will be (3) bash plates that need to be removed in order to install the Wholesale Automatics Cooler Kit

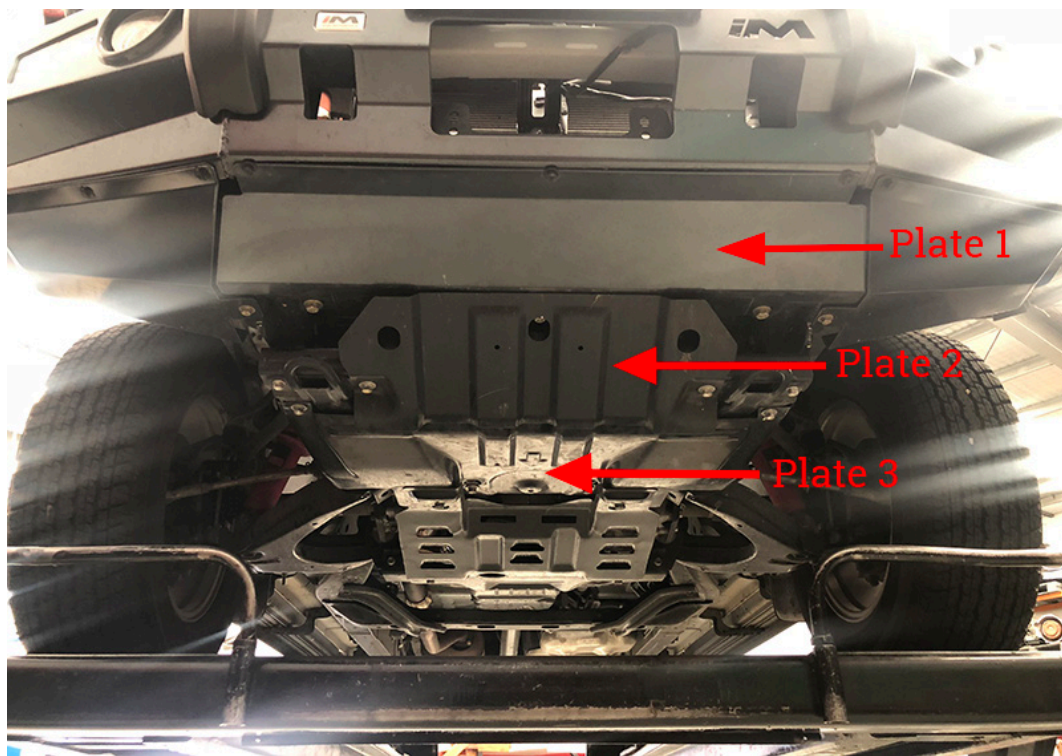

11. To remove Plate 1 (refer previous photograph) begin by removing the (3) 10mm bolts attaching the plate to the vehicle. Next remove the (2) 17mm head bolts on either side of the same plate and gently slide the plate out towards the front of the vehicle to remove it.
12. To remove Plate 2, remove the (3) 17mm head bolts inside the holes, followed by removing the (2) 14mm head bolts located on the bottom of the plate. Gently slide the plate towards the front of the vehicle to remove it.
13. To remove Plate 3, remove all (6) 14mm head bolts and gently lower it to remove it from the vehicle.
14. Remove the (2) OEM hose clamps by squeezing to release them. These are located on the rubber transmission line indicated in the photo below.

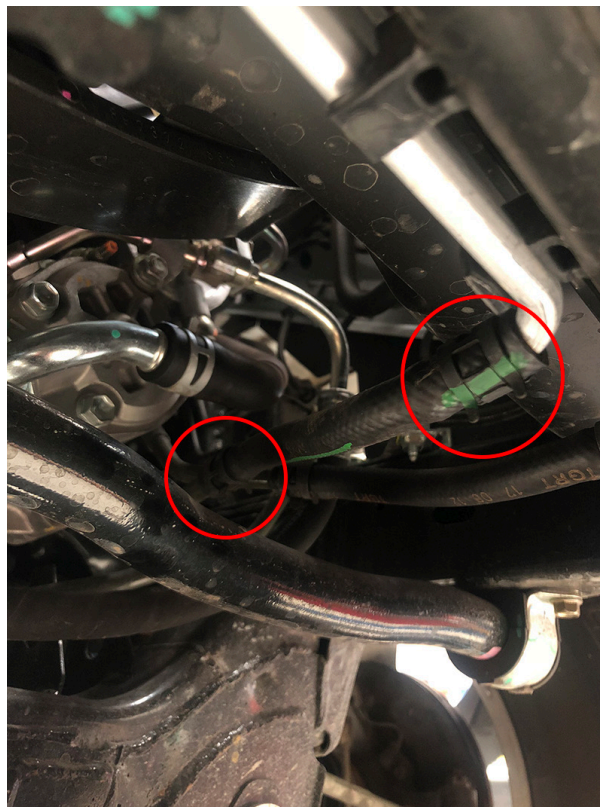

15. Gently remove the hose that was attached by the OEM hose clamps. This will expose the (2) union fittings you will be using to plumb in the Wholesale Automatics Cooler.

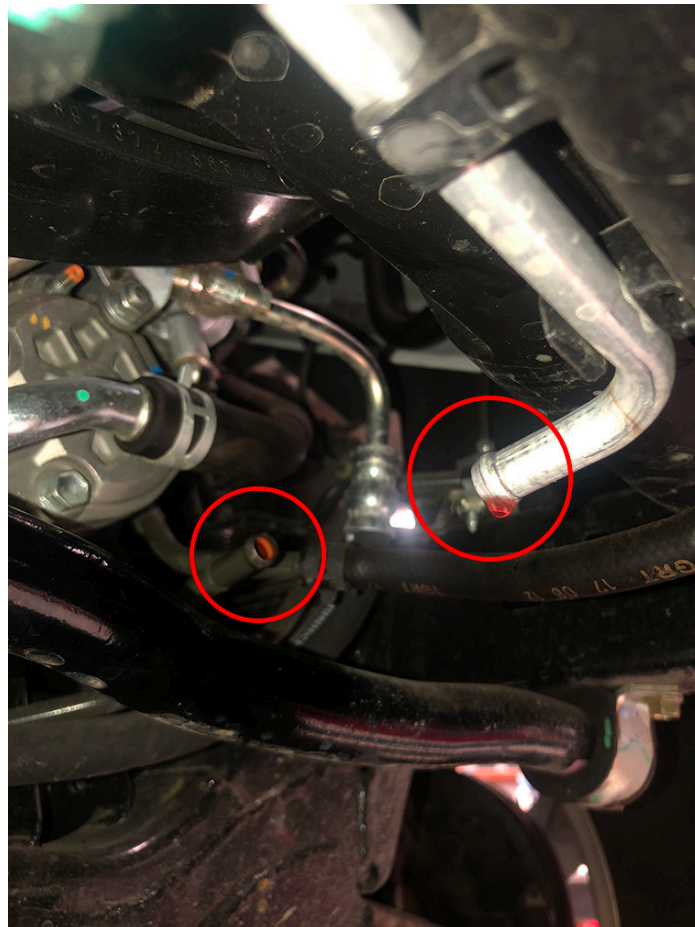

16. Remove the union fitting rubber socks from the supplied cooler.

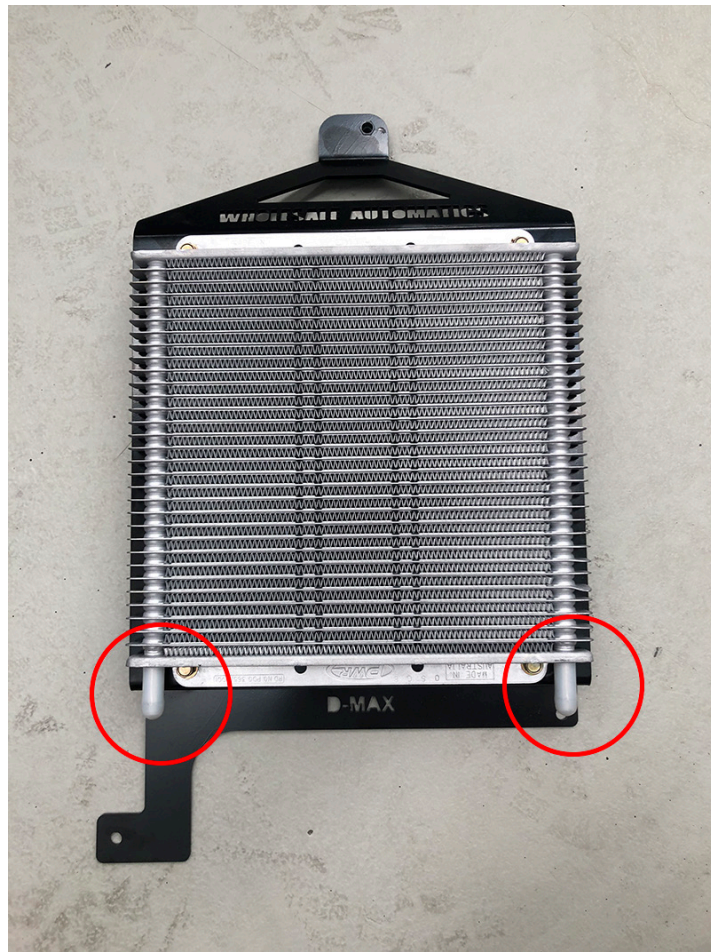

17. Cut the supplied rubber hose in half and fit each half to either of the union fittings on the supplied cooler. Do not use lubricant to fit the hoses.

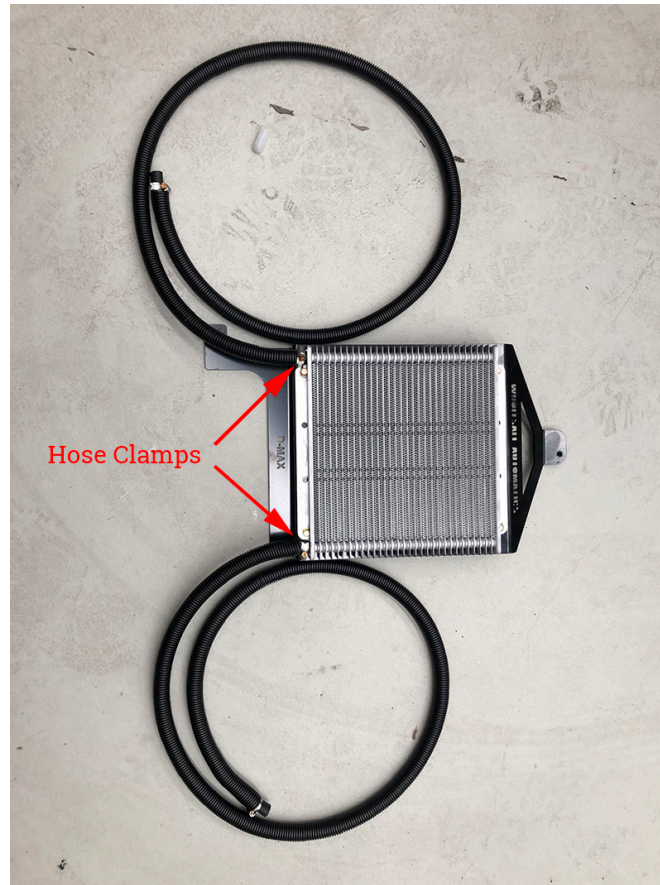

18. Make sure each hose fitted onto the cooler is secured and clamped tightly with the supplied hose clamps as indicated in the previous photograph.

19. Carefully feed the two cooler lines through the top of the vehicle's engine bay and carefully manoeuvre the cooler bracket into place behind the front grill (refer following photos).



20. Using the (1) 10mm head bolt supplied, tighten the bolt into the top of the bracket through the top of the radiator support into the cooler bracket nutsert.



21. Refit the (1) 10mm head bolt that was earlier removed from the centre brace on the bottom of the radiator support through the Wholesale Automatics cooler bracket back into its OEM hole located on the passenger side of the centre brace of the lower radiator support.

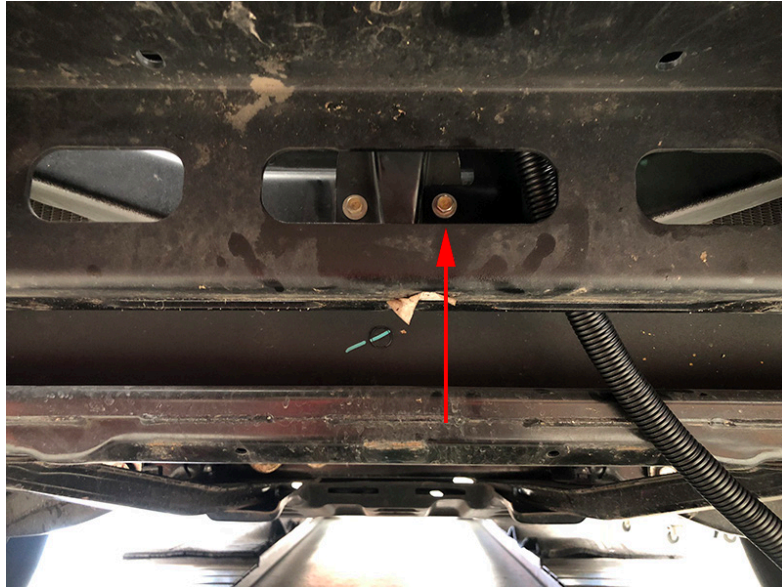

22. Reinstall entire grill assembly by reversing the steps taken earlier to remove the grill.

23. Route the rubber transmission lines coming from the cooler supplied over the front chassis support and under the radiator.

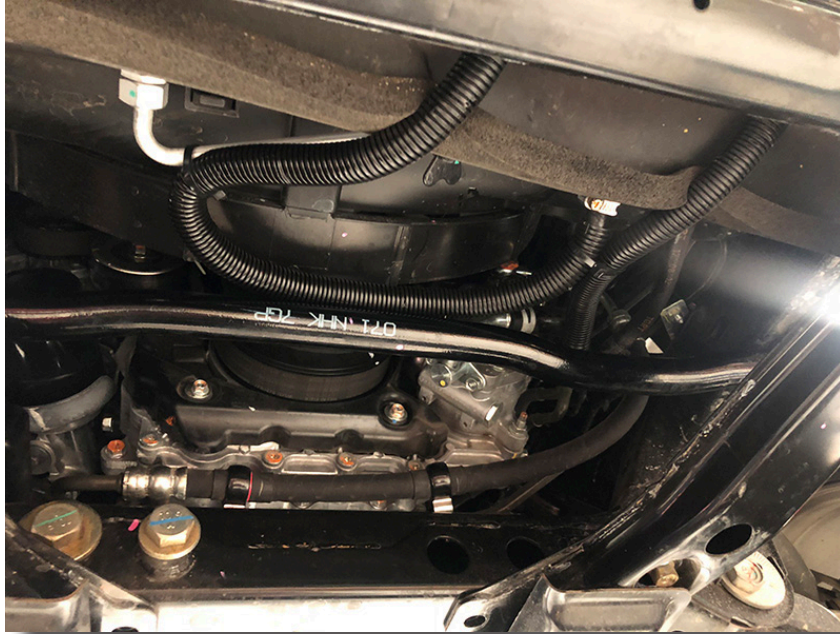

24. Roughly route each cooler line to either of the union fittings earlier exposed when the OEM rubber transmission hose was removed. The lines can be routed to either fitting - it does not matter which one. Cut off the excess rubber hose.

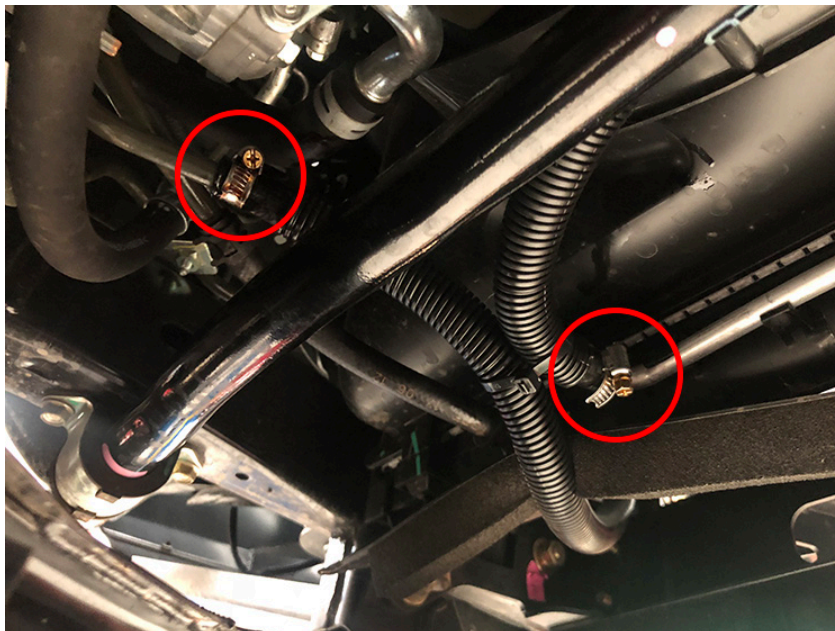

25. Route the new transmission lines in such a way that they will run comfortably with no kinks to the desired OEM union fittings and secure with the supplied stainless steel hose clamps. Secure the transmission lines as required with supplied cable ties (refer photo following).

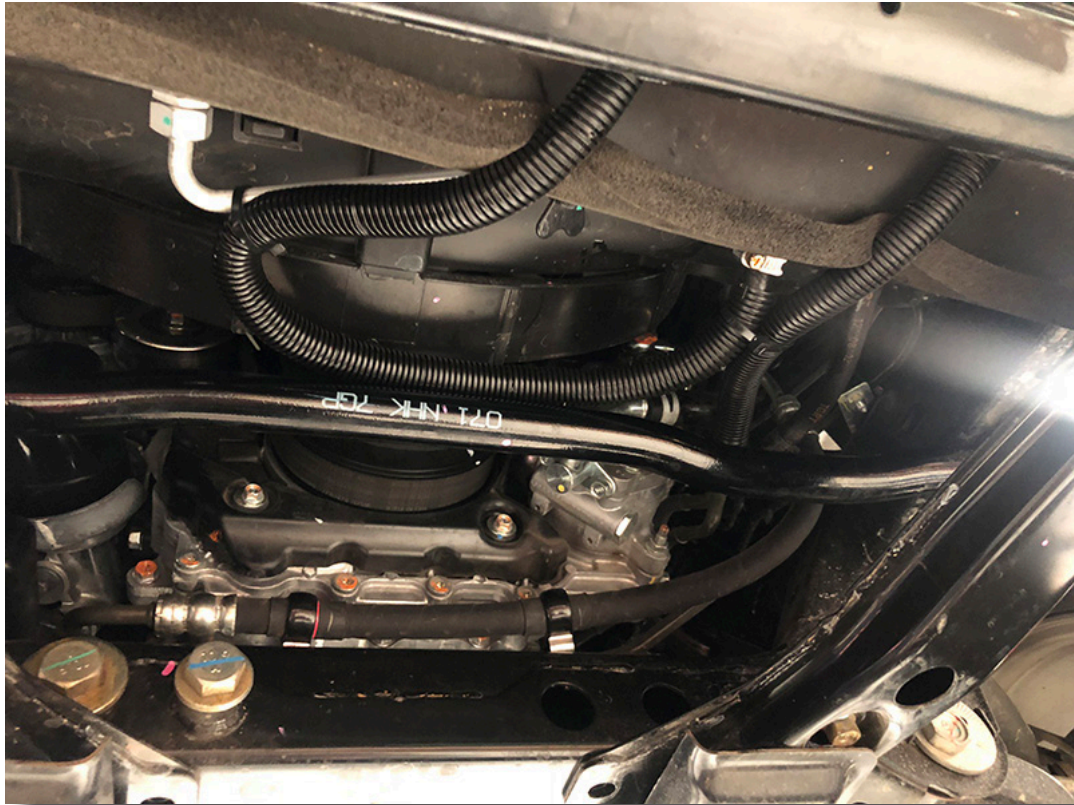

26. Recheck all fittings are tight.

27. We now need to start the engine to check the fluid level of the transmission.
28. Remove the Fill Plug (1) 24mm head bolt located on the driver side of the car towards the rear of the transmission next to the extension housing.

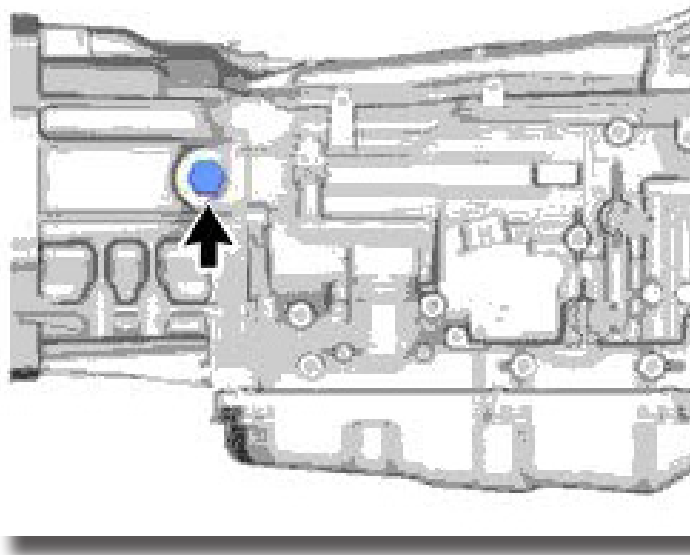

29. ONLY when the engine is running - remove the Check Valve bolt from the bottom of the transmission pan using a 5mm Allen key.

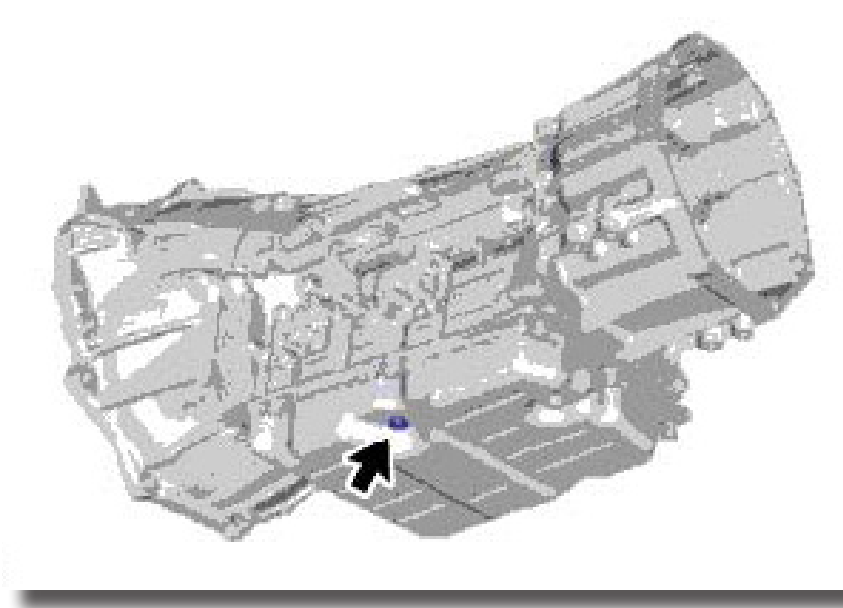

30. Add OEM or equivalent transmission fluid into the fill hole where the 24mm bolt was removed. Continue to fill the transmission until the fluid starts to run out of the check valve hole. When this happens, stop pumping fluid into the transmission and wait for the fluid coming out of the check valve to slow to a dribble. With the handbrake on and your foot on the brake, shift the transmission into Park, Reverse, Neutral, and Drive to ensure that all the chambers in the auto have been filled. If there is no fluid coming out of the check valve hole, you will need to add some more.

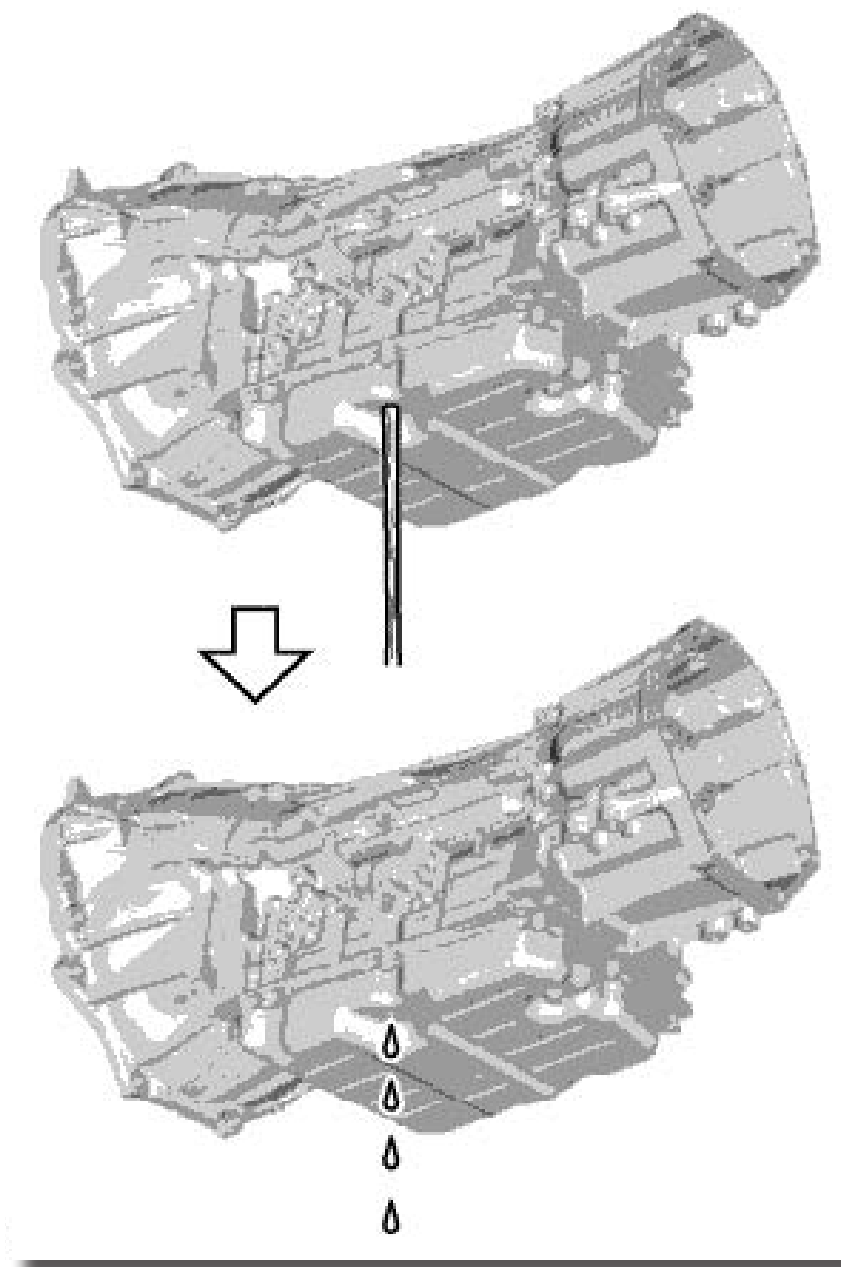

31. Before the fluid stops completely, reinstall the Check Valve Bolt and tighten.
32. Reinstall the Fill Plug (1) 24mm head bolt into its original thread.
33. Clean all underneath areas of transmission fluid
34. Before reinstalling bash plates, road test vehicle for at least 15 mins to ensure no air pockets or leaks.
35. After road test, visually check for leaks and retighten any fittings as required.
36. With the engine still running, recheck fluid level by removing the Check Valve Bolt and seeing the oil dribble out per point 30. If no oil is present please start from Point 27

**PLEASE NOTE: THE TRANSMISSION FLUID MAY BE QUITE HOT.
PLEASE TAKE CARE WHEN UNDOING CHECK VALVE BOLT.**

37. Check again for any transmission fluid on the vehicle and clean off.
38. Re install bash plates in reverse order they were removed.
39. Road Test vehicle one last time to ensure everything is correct.

This completes the installation of the Wholesale Automatic Transmissions External Cooler kit to suit the Isuzu D-Max or MU-X.

Please remember ALL automatic transmissions have a service interval of 2 years or 40,000km to improve the longevity of the transmission.