



# Dual External Transmission Oil Cooler Kit Suitable for:



**Ford Ranger PX 10 Speed 10R80  
Ford Everest UA 10 Speed 10R80**

**WITH THE FOLLOWING ENGINES:**

**EcoBlue 2.0L Bi Turbo Diesel - 2018 to 06/2022**

Please read through all of the instructions carefully before proceeding. If any of the information does not appear correct or the diagrams don't match your vehicle, please contact Wholesale Automatic Transmissions on +61 3 9762 8004.

# Parts List

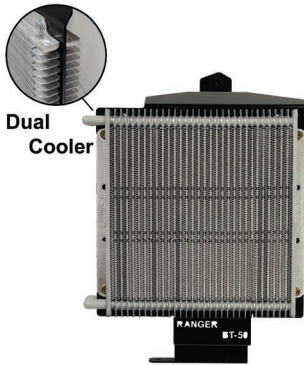

1 x Dual Cooler Bracket with coolers fitted



1 x 'J' pipe with Rubber Lined 'P' clamp



5m x High Temp Cooler Line Hose with Conduit  
1x Dual Cooler Link Hose

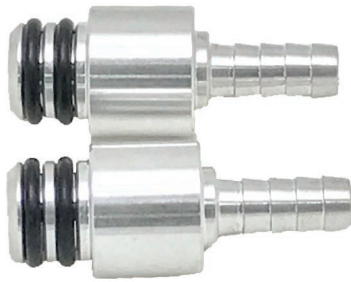

2 x Custom Cooler Unions with O-Rings



1 x M6 x 20 SEMS Bolt  
1 x M6 x 30 SEMS Bolt and Nut  
2 x Metal Self Tappers



6 x 8-16 Screw Clamps  
2 x 14-27 Screw Clamps



1 x Union Support Bracket for 10R80 only



1 x 'L' Bracket

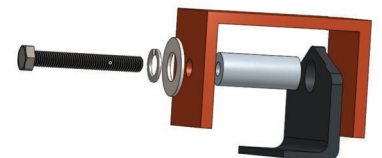

1 x Optional top mount bolt spacer kit

Expected Installation Time: 3 Hours

## Summary of Installation - For Experienced Fitters

- SAFETY FIRST: Allow engine, auto and fluid to cool prior to starting work to prevent serious injury.
- Remove front grill and bash plates
- Fit the connector hose to the upper union of the front cooler and the lower union on the rear cooler. Secure with two (2) supplied 8-16 screw clamps.
- Fit the 5m cooler line to the cooler with two (2) supplied 8-16 stainless steel screw clamps before lowering into position (unless you have go-go gadget fingers).
- Fit the top bolt by locating mounting bracket behind radiator support panel into the hole approx 100mm to the right of the bonnet latch. The optional top mount spacer kit may be required in some situations.
- Check that the cooler and bracket have plenty of clearance and that the bracket is sitting straight, then install the lower two self tapping screws.
- Cable tie cooler lines as you work your way to the heat exchanger mounted to the passenger side of the auto, just above the drive shaft. Make sure the engine oil filter to be removed for engine maintenance when you are cable tying the lines.
- Accessing through the passenger wheel arch, use hose clamp pliers to clamp the 2 x black coolant hoses connected to the heat exchanger.
- Remove three (3) T40 Torx bolts if you can. You may need to drop crossmember to remove bolts. Remove the heat exchanger, do not discard bolts. Refit crossmember.
- Fit custom cooler unions to transmission and secure with supplied union support bracket & a bolt removed from heat exchanger.
- Fit 'J' pipe to coolant hoses and clamp with the supplied two (2) 14-27 screw clamps and release hose clamp pliers. Use 'P' clamp to secure 'J' pipe to a vacant bolt hole. You may need to use the 'L' bracket and M6 x 30 SEMS bolt and nut if your transmission doesn't have a threaded hole in the correct location.
- Cable tie lines in place and then cut cooler lines to length leaving a little slack for movement. Fit cooler lines using two (2) supplied 8-16 screw clamps.
- Check clearance of hoses and fittings to any other moving/hot part. If needed, top up engine coolant and/or transmission fluid with the recommended fluid
- Test drive vehicle for 15mins and then check all hoses and fittings leaks and also check mounts and bolts are tight. Clean any oil or coolant residue off vehicle. Road test. Check for leaks, re-tightening if necessary. Re-check fluid levels.
- Refit any bash plates, grills, aftermarket accessories removed.

# 1. Detailed Installation Instructions

Before commencing work, please ensure that you have at least 2L of transmission fluid to top up the transmission, and sufficient coolant to either fully fill or top up at the end of the job. Please read through all of the instructions to familiarize yourself with the process first.

- 1.1. Remove the front grill of the vehicle and any bash plates that are covering/protecting the transmission and radiator.

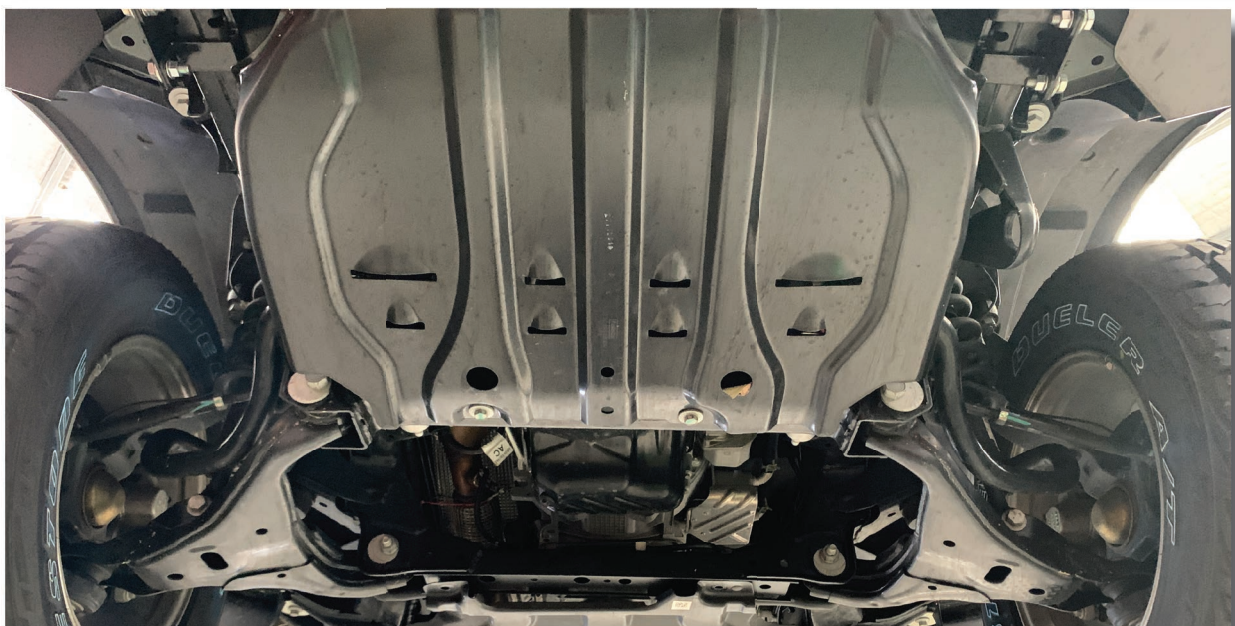

- 1.2. Face the bracket with the pre mounted coolers towards you. Fit the Dual Cooler Connector Hose to the upper union of the front cooler and the lower union on the rear cooler. Secure with two (2) supplied 8-16 screw clamps.



- 1.3. Fit the 2 ends of the 5m length of cooler line hose to the remaining cooler unions using two (2) stainless steel screw clamps before lowering into position due to the lack of space. Do not cut the looped end of hose yet.
- 1.4. Feed the cooler and hoses down into the passenger side area and hook the bracket behind the hole approximately 100mm to the right of the bonnet latch in the upper radiator support panel and fit the M6 x 20 SEMS bolt through the hole and into the thread in the mounting bracket.

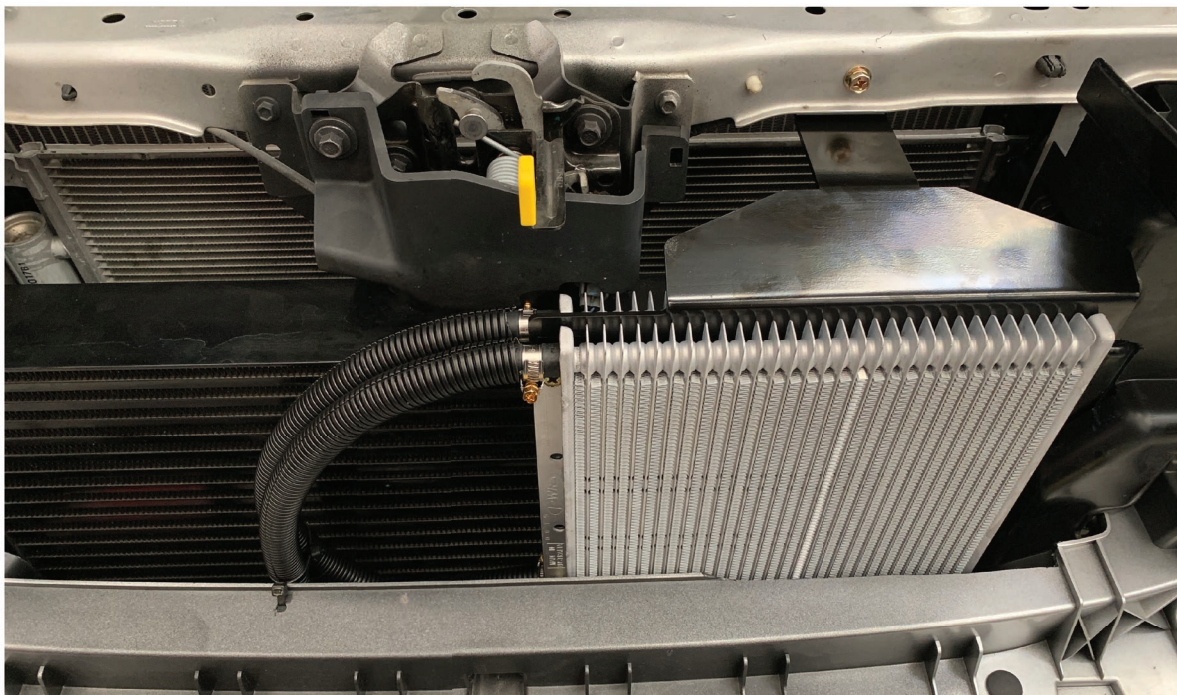

- 1.5. Some variants may have factory bumpers that will prevent the cooler from mounting all the way forward. There are also some variants that have grills that will hit the cooler when trying to refit the front grill into place. If you have one of these variants you have 2 options.

**Option A:** Use the optional top mounting bolt and spacer to move the top of the bracket away from the grill and bumper. This will provide sufficient clearance at the front of the cooler. If you have an aftermarket intercooler fitted, this may not work so we would recommend choosing Option B.

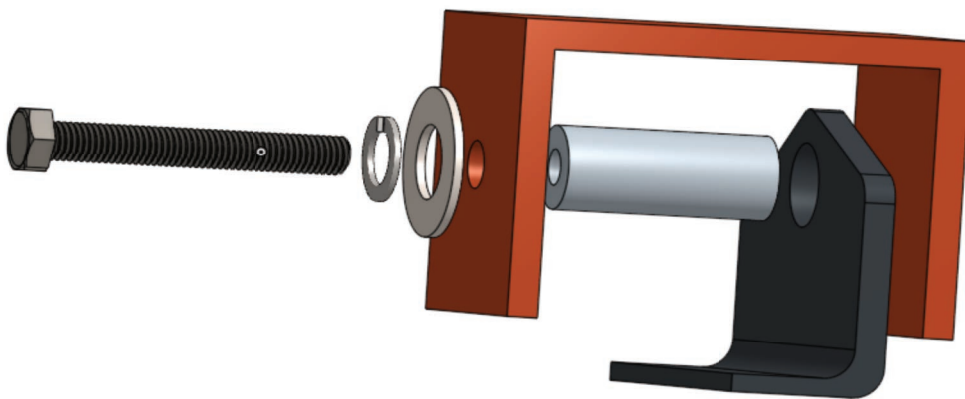

**Option B:** Trim the bumper and rear of grill to provide clearance to the cooler. Usually it only requires the small raised section at the back of the bumper (approx 5mm) to be trimmed and about 5mm of the rear of the grill to allow enough clearance for the cooler.

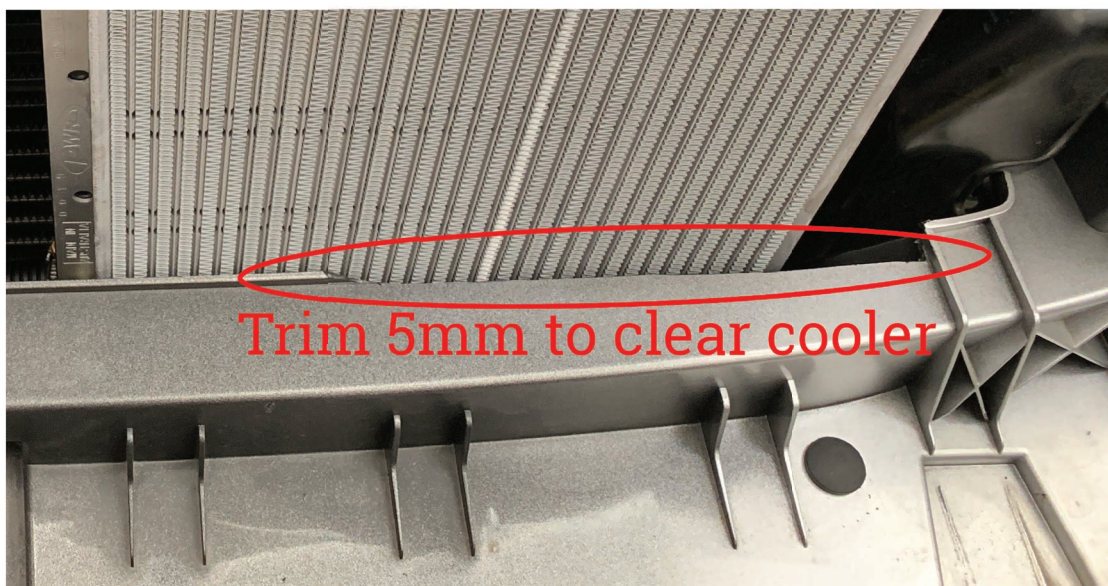

- 1.6. From under the vehicle, secure the lower section of the bracket to the under side of the lower radiator support panel using the 2 x Metal Self Tapping screws. Before installing the screws, please make sure the cooler has clearance around it to prevent rubbing against any part of the car.



- 1.7. Create a slack loom in the cooler lines and cable tie the lines to the lower radiator support panel to reduce strain on the cooler fittings.



- 1.8. Feed the loop end of the lines through the gap directly above the chassis on the passenger side just behind the radiator support panel. Cable tie the cooler lines to the support panel along the way. Some vehicle variants may have an existing factory line running through this location - for those vehicles you will need to route the cooler lines under the radiator.



- 1.9. In the passenger side wheel arch, remove the rear rubber splash protector by removing the plastic screw clips and move protector out of the way.





- 1.10. Cable tie cooler lines firmly to the vehicle but not too firm that they cause flow restrictions and so that they are not too tight between tie points. Ensure the cooler lines do not prevent access to the engine oil filter by cable tying them to the air con lines above the engine oil filter.

The lines need to reach the area on the passenger side of the automatic, just above front prop shaft. (Do not cut the hose yet)

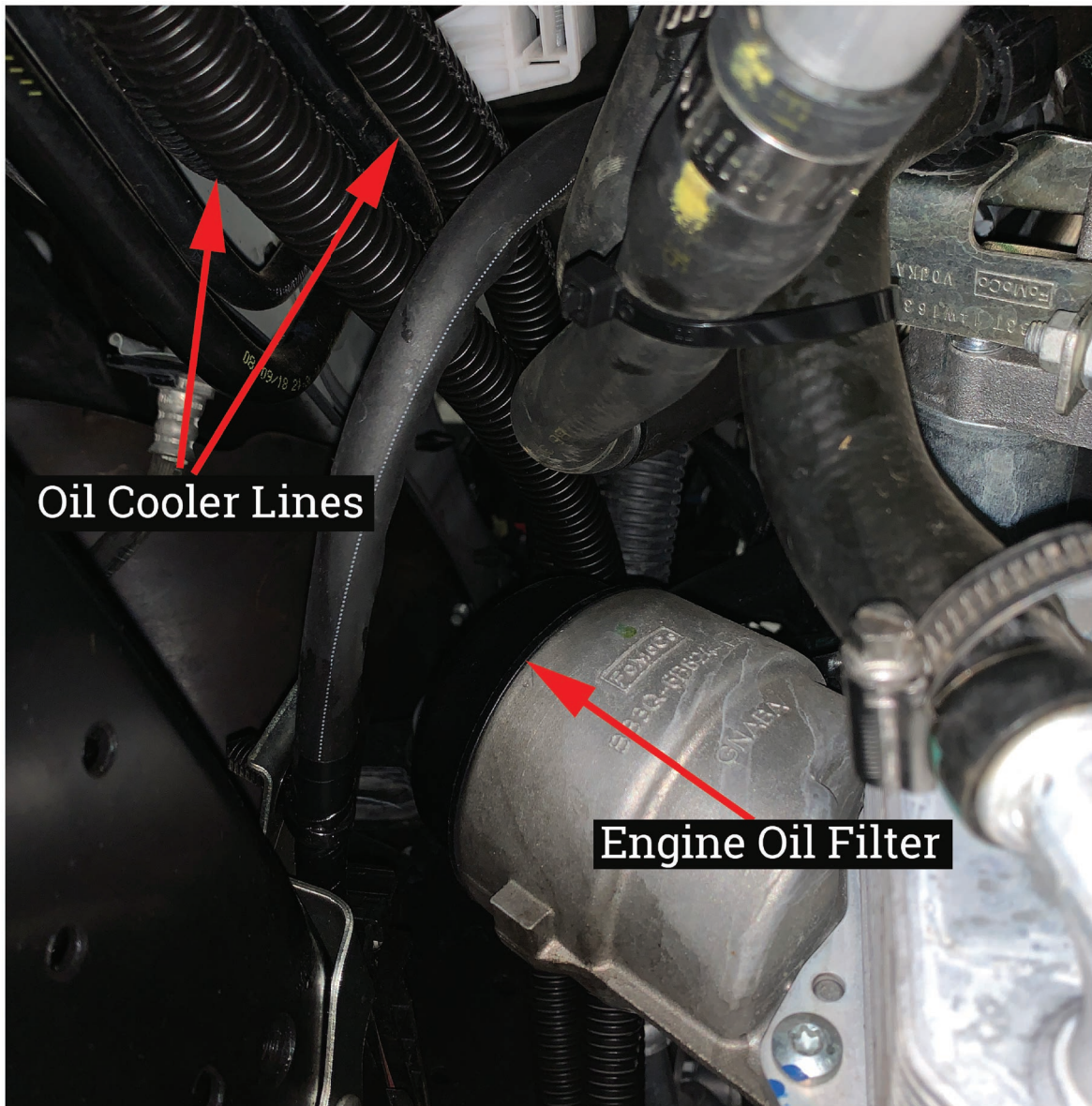

- 1.11. Use clamps to restrict the flow of coolant through the 2 hoses to be disconnected from the heat exchanger. **If you don't have clamps, the cooling system must now be drained; refill and bleed the cooling system after completing the install. Ensure you have sufficient coolant to re-fill the coolant system.**



- 1.12. Remove coolant hose clamps and then remove the hoses from the heat exchanger. Make sure you have a drain tin or bucket under the hoses to catch the small amount of coolant that will leak from these hoses once they are disconnected..



- 1.13. Using a T40 Torx bit, remove the three bolts holding the heat exchanger to the transmission. Don't discard the bolts.

The top two bolts are extremely difficult to access. If your tooling doesn't provide you access to these bolts, see next step. If you are able to get these bolts out without removing the crossmember, skip to step 1.18.

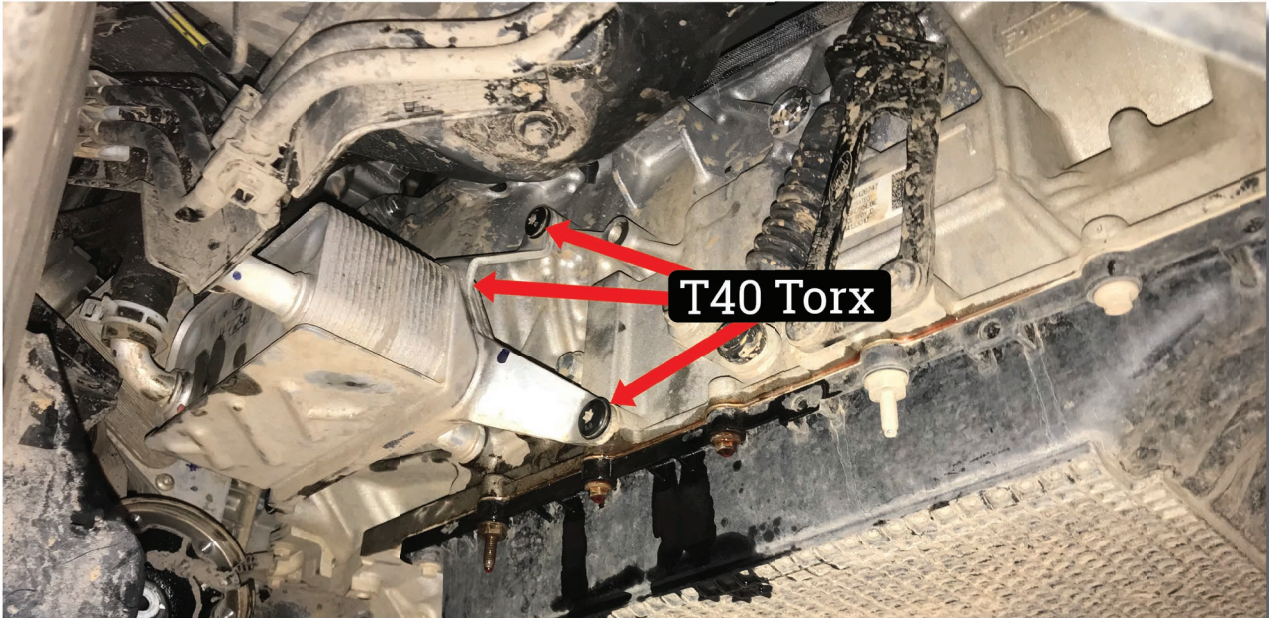

- 1.14. If you can't access the upper heat exchanger bolts you will need to lower the crossmember. First, you will need to support the transmission with a transmission jack or adjustable support before unbolting the crossmember.



- 1.15. Start by unbolting the exhaust mounting on the drivers side above the crossmember and remove the nuts from the four (4) crossmember bolts.

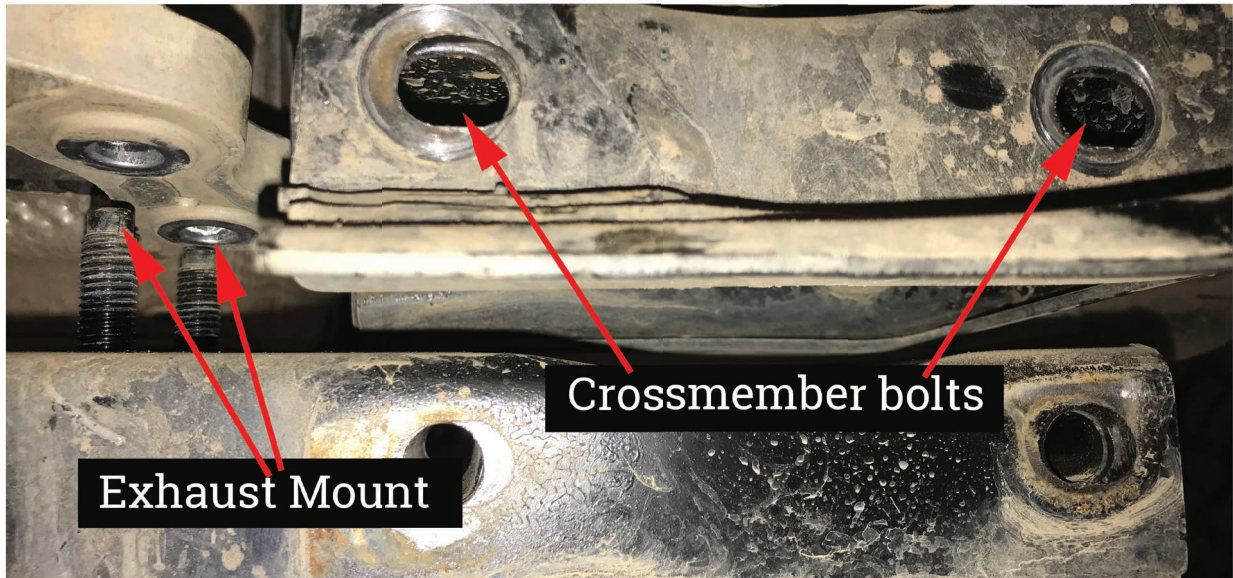

- 1.16. Take the weight of the transmission and crossmember on the transmission jack/ support so that you can remove the crossmember bolts completely. Once the bolts are removed, slowly lower the transmission and crossmember down approx 50mm while monitoring any wiring or hoses that might get snagged.
- 1.17. With the transmission lowered, you will now be able to access the upper two (2) bolts on the heat exchanger. Don't discard the bolts.

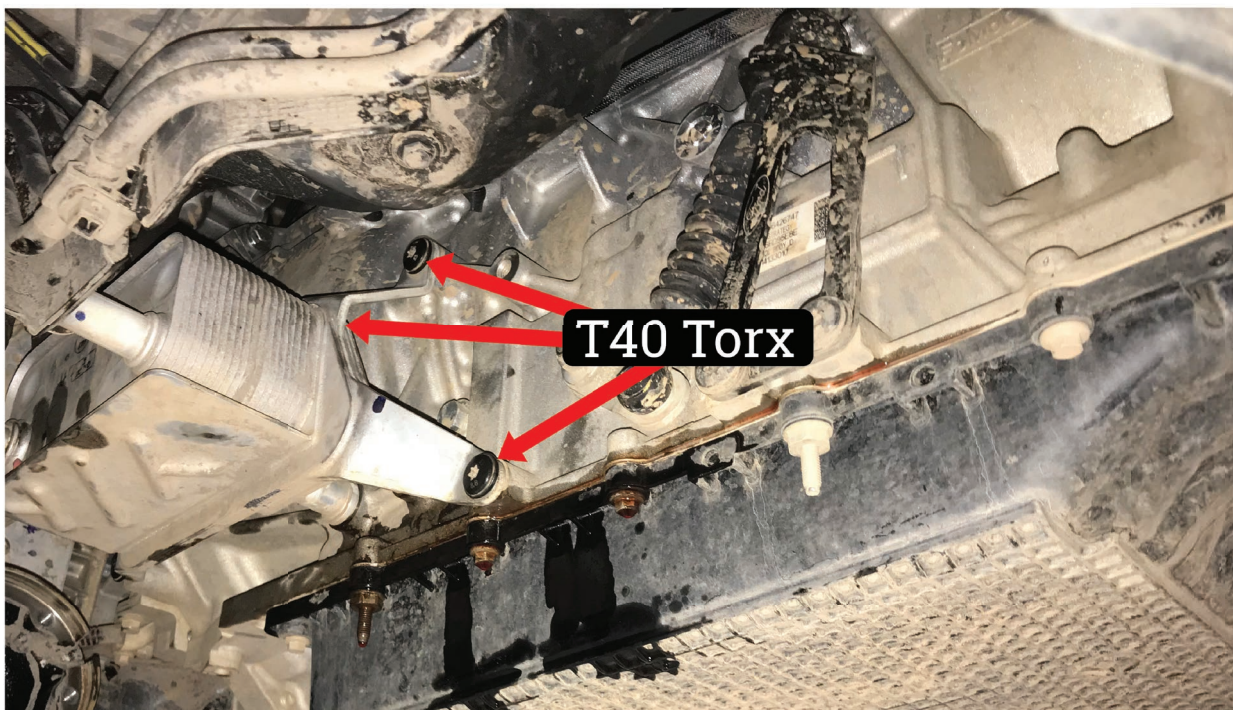

- 1.18. Gently remove the heat exchanger from the transmission by pulling it horizontally away from the transmission. Have a drain tin or bucket underneath as some transmission fluid may come out.
- 1.19. Install the supplied custom cooler unions. Check that each union has two (2) o-rings fitted prior to installation, and apply a small amount of transmission fluid to both o-rings on both unions to provide lubrication. Install the unions by carefully inserting them into the empty fittings in the side of the transmission left behind by the removal of the heat exchanger. Secure the new unions with the supplied bracket, using one of the T40 Torx bolts previously removed from the heat exchanger.

*\*Note\**: if installing with a temperature gauge the union to use for the temperature sensor is the rear union. This is the hot fluid output from the transmission.



- 1.20. Fit 'J' pipe to the coolant hoses removed from the heat exchanger, pushing the hoses as far as possible onto the 'J' pipe. Test that you can easily manoeuvre this assembly near one of the vacant heat exchanger bolt holes for securing the 'J' pipe after assembly. Secure the coolant hoses using the two (2) larger 14 - 27mm hose clamps.
- 1.21. Secure the 'J' pipe to one of the vacant heat exchanger bolt holes using the supplied rubber lined 'P' clamp and one of the previously removed T40 Torx bolts. If your transmission doesn't have a threaded hole in this location, use the 'L' bracket and M6 x 30 SEMS bolt and nut to secure the 'P' clamp to the nearest threaded hole.



- 1.22. Check the routing of the cooler lines prior to cutting to ensure they will not impact on any part of the vehicle or could become jammed or pinched. Cable tie them so they keep sufficient clearance around the Engine Oil Filter for ease of engine maintenance.

- 1.23. Measure where they need to be cut for the unions while allowing for some slack between the unions and the first cable tie point.
- 1.24. Cut rubber cooler lines to length and pull back the conduit. Slide the remaining small screw clamps onto the cooler hose and then insert the hoses onto the unions. Do not use any lubricant on the barbed fittings.

Re-fit conduit into place, trimming it to length if necessary.

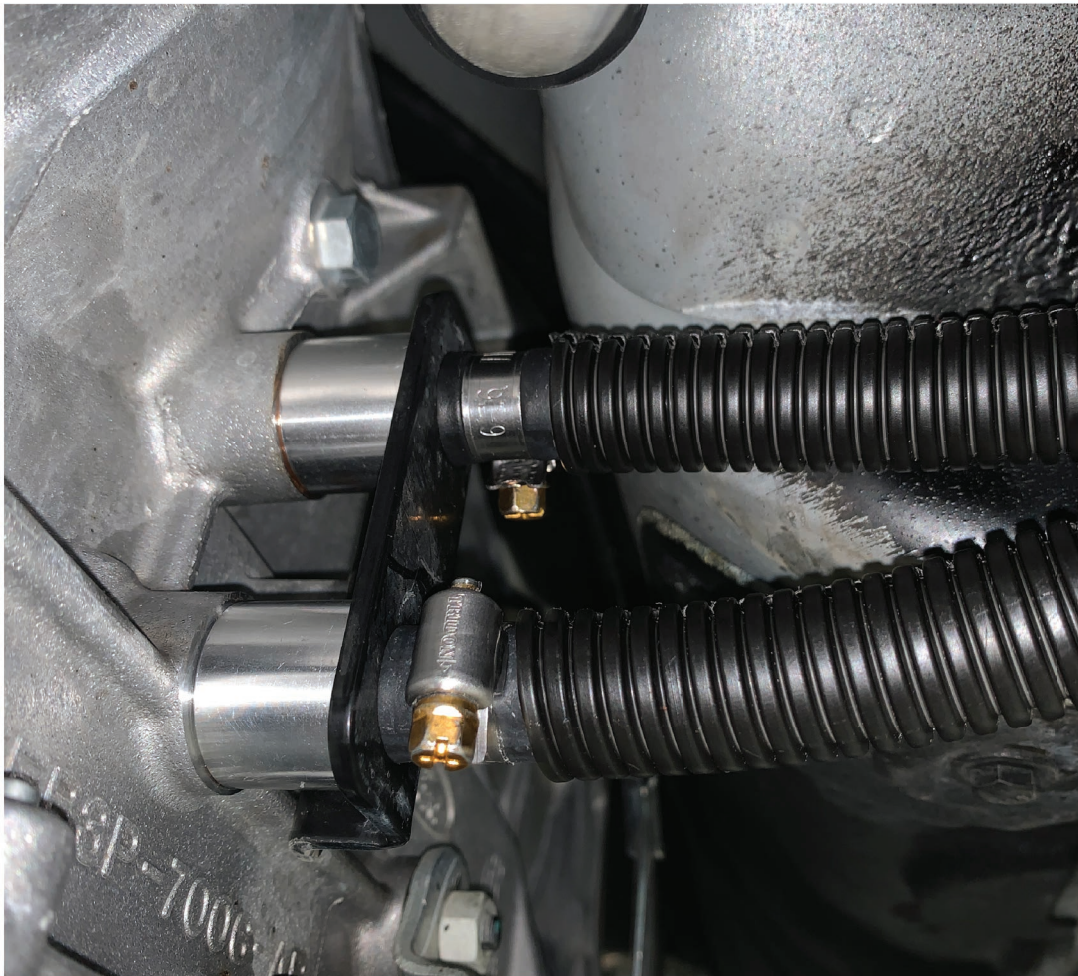



- 1.25. Check clearance of hoses to front prop shaft. Cable tie the coolant hoses to prevent rubbing.

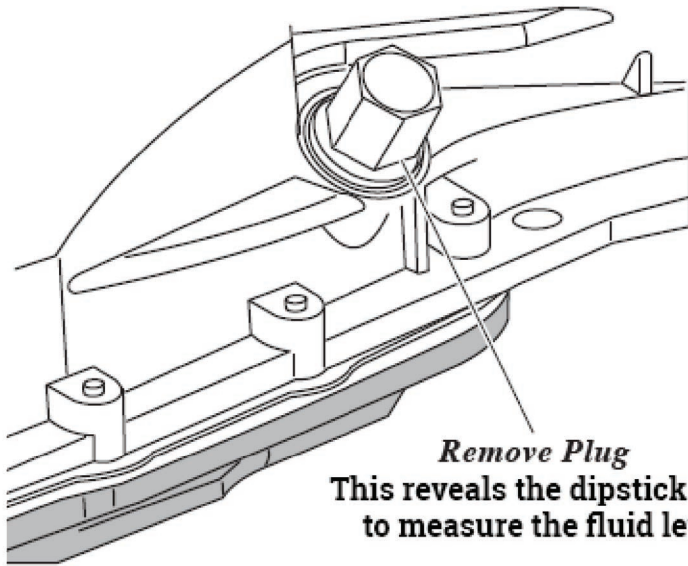

- 1.26. Recheck transmission coolers, fittings, hoses, unions, mountings and clamps for any leaking or loose fittings. Tighten if necessary.
- 1.27. Check the coolant level. If the engine cooling system was drained while removing the heat exchanger now is the time to re-fill and bleed the cooling system with coolant that meets or exceeds the genuine coolant specification. If you were able to clamp the lines the cooling system should only require a small top up.
- 1.28. Check the transmission fluid level and if necessary, top up with Genuine Transmission Fluid or any full synthetic transmission fluid that meets or exceeds the genuine oil specification.
- 1.29. Check engine coolant level and top up with the manufacturers recommended coolant.
- 1.30. Clean any spilled engine coolant or transmission fluid from under the vehicle so that it is easy to detect a leak. You can use brake cleaner as it will evaporate quickly. Avoid spraying exhaust and body work with brake cleaner or solvent.
- 1.31. Road test vehicle for a minimum of 15 minutes. Try to find a couple of hills that will get the transmission to work hard.
- 1.32. Check the transmission coolers, fittings, hoses, unions, mountings and clamps for any leaking or loose fittings. Tighten if necessary.
- 1.33. Check engine coolant level and transmission fluid level again. Top up levels if necessary.
- 1.34. Refit any bash plates, front grills, aftermarket accessories that were removed during the fitment of the cooler kit.

**FLUID FILL PLUG**

*Remove Plug*  
This reveals the dipstick used  
to measure the fluid level

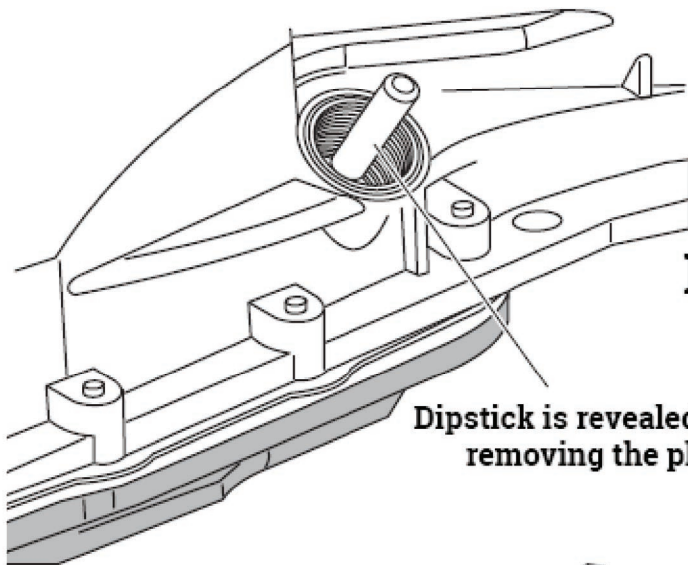
**FLUID LEVEL INDICATOR**

Dipstick is revealed after  
removing the plug

**The recommended  
transmission fluid for  
Ford 10R80 10 Speed  
meets or exceeds the  
Mercon ULV<sup>®</sup> standard.**

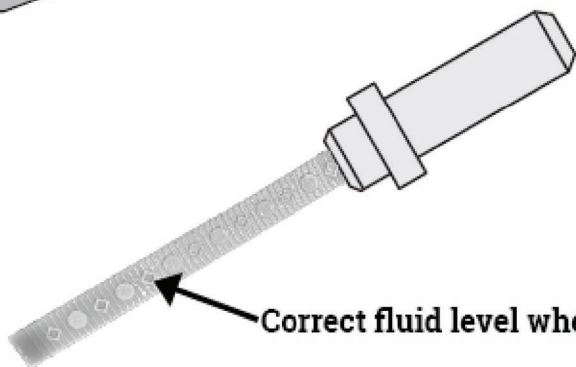

Correct fluid level when hot

*Check fluid level hot idle in park*

# This completes the installation of the Dual External Transmission Oil Cooler Kit: Ford Ranger PX 10 Speed Ford Everest UA 10 Speed

Please remember ALL automatic transmissions have a service interval of 2 years or 40,000km to improve the longevity of the transmission.

---

## Please Provide us with Feedback

If you have a minute to provide us with some feedback about your experience with Wholesale Automatic Transmissions and our products, that would be greatly appreciated.

Using your smart phone or device's camera app, point at the QR code below to take you straight to our feedback page for you to choose the most appropriate feedback method.

