



# External Transmission Oil Cooler Kit

## Suitable for:







**Ford Ranger Next-Gen  
Ford Everest Next-Gen  
VW Amarok Next-Gen**





**WITH THE FOLLOWING ENGINES:  
3.0L V6 Turbo Diesel with 10 Speed Auto**

Please read through all of the instructions carefully before proceeding. If any of the information does not appear correct or the diagrams don't match your vehicle, please contact Wholesale Automatic Transmissions on +61 3 9762 8004.

# Parts List

			
2 x 3/8" Cross Flow Oil Coolers pre mounted	4.5m x 3/8" High Temp Cooler Line Hose	0.50m x 3/8" Cooler Joining Hose Conduit	1 x 'L' Pipe

			
2 x 6R80/10R80 Cooler Unions with O-rings	1 x Union Clamping Bracket	1 x Plate With Nutsert	6 x 14-16mm Hose Clamps

			
3 x M6 x 25 SEMS Bolts	6 x 300mm Cable Ties	2 x M10 Washer for spacer	1 x 14-27mm Hose Clamp

Expected Installation Time: 3 Hours

## Summary of Installation - For Experienced Fitters

- SAFETY FIRST: Allow engine, auto and fluid to cool prior to starting work to prevent serious injury.
- Remove the top cover from over the radiator.
- Using a T30 Torx bit, remove the screw holding the air inlet snorkel to allow you to easily remove and reinstall the cover.
- Remove the two bolts that secure the top of the grill
- Disconnect water feed and camera plug before removing the grill
- Remove number plate and holder to allow access to the front grill
- Remove grill by pulling forward to release clips along the bottom
- Remove the clips holding the small panel on the drivers side
- Remove bash plate
- Position cooler in the vehicle with hoses pointing towards the passenger side. Secure passenger side of bracket to the center support using bolts provided
- Use plate with Nutsert and bolt provided to secure drivers side of bracket
- Route hoses under air conditioning condenser and along to transmission
- Remove heat exchanger from side of transmission
- Use 'L' pipe to bypass heat exchanger
- Remove heat exchanger bracket and use two (2) M10 washers as spacers under Gear Shift cable bracket
- Insert unions and secure with clamping bracket provided
- Cut hoses to length and secure with hose clamps provided. Rear union is the hot oil output and we recommend running through the rear cooler first.
- Check clearance of hoses and fittings to any other moving/hot parts. If needed top up engine coolant and/or transmission fluid with the recommended fluid
- Test drive vehicle for 15mins and then check all hoses and fittings for leaks and also check mounts and bolts are tight. Clean any oil or coolant residue off vehicle. Road test. Check for leaks. Re-tighten if necessary. Re-check fluid levels.
- Refit any bash plates, grills, aftermarket accessories removed.

# 1. Detailed Installation Instructions

Before commencing work, please ensure that you have at least 2L of transmission fluid to top up the transmission, and sufficient coolant to either fully fill or top up at the end of the job. Please read through all of the instructions to familiarize yourself with the process first.

- 1.1. Open bonnet.
- 1.2. Remove the top cover above the radiator. There are 13 plugs that need to be removed as shown below. Unscrew the center from the plug body and remove both parts.

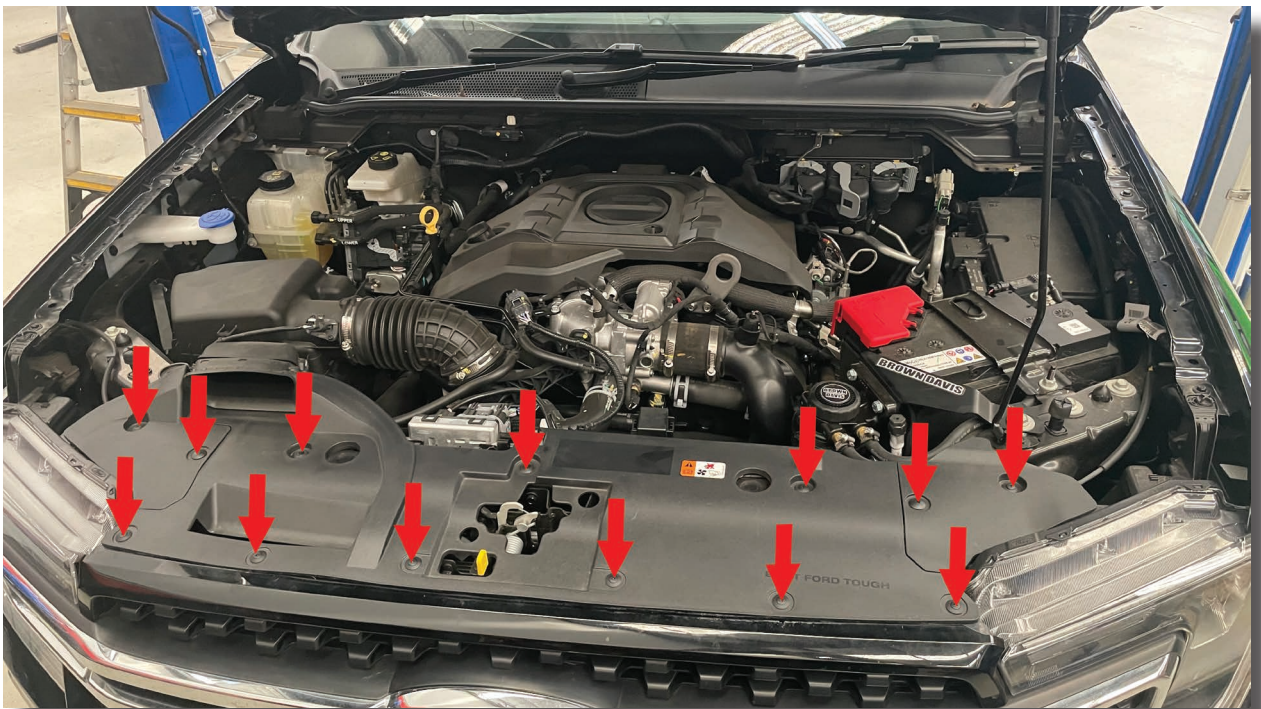

- 1.3. To remove plugs use a larger Phillips screwdriver to remove center plug. Once the center plug is removed the outer plug body can be removed.



- 1.4. Using a T30 Torx bit, remove the screw holding the air inlet snorkel to allow you to easily remove and reinstall the radiator cover.



- 1.5. Remove the two 10mm bolts holding the top of the grill in place as shown.

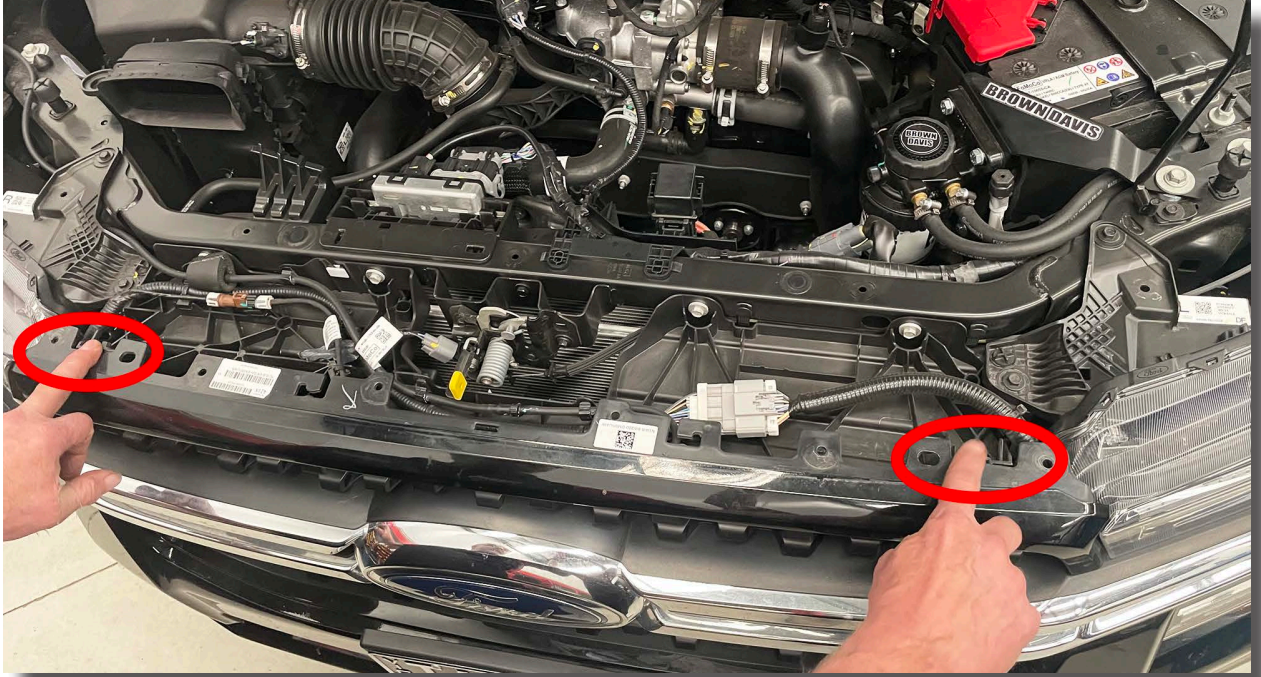

- 1.6. Disconnect the brown plug on the drivers side of the vehicle, and the water pipe in the center. Be sure to position the pipe ends so as to minimise loss of water.



- 1.7. Remove the number plate and the 2 x 10mm bolts retaining the number plate holder to gain access to the front grill.



- 1.8. Working along the base of the grill, pull forward to dislodge the clips holding it in place. Clips can be difficult to dislodge and may need to be released from behind the grill



- 1.9. Remove the 3 plugs holding the plastic cover on the drivers side of the vehicle. Remove the cover and place out of the way for now.

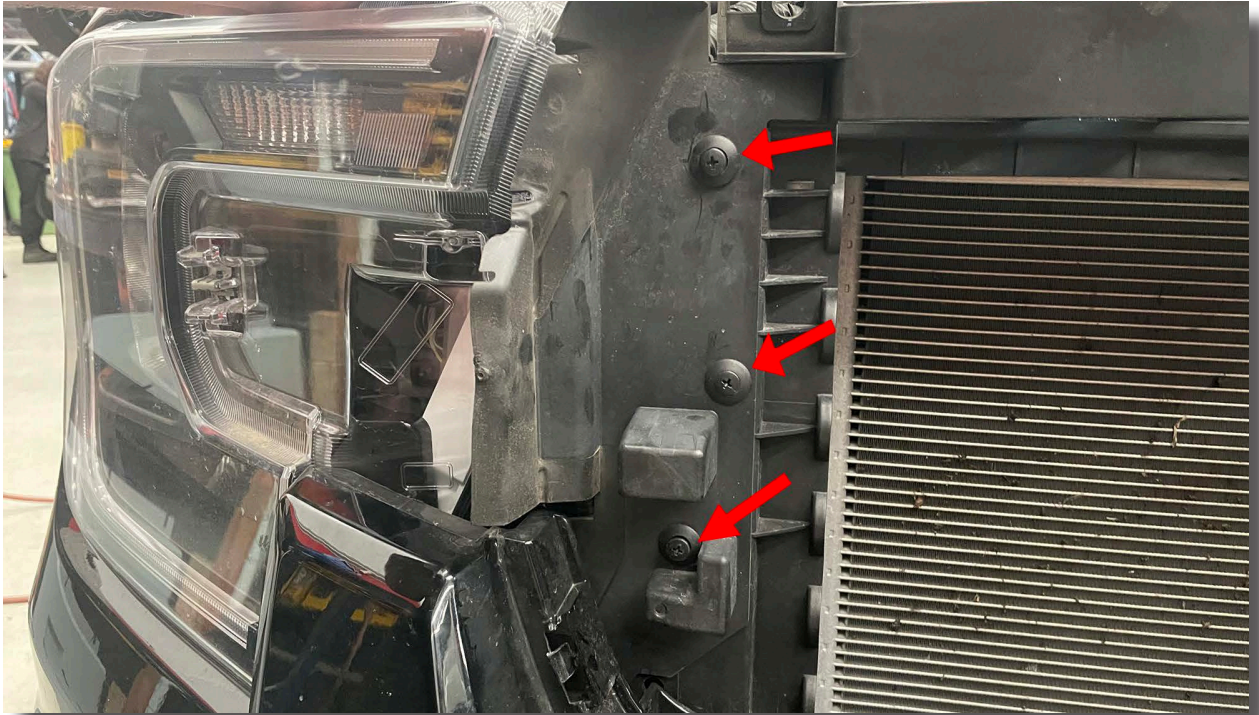

- 1.10. Remove the 4 bolts holding the bash plate under the front of the vehicle and place safely out of the way.

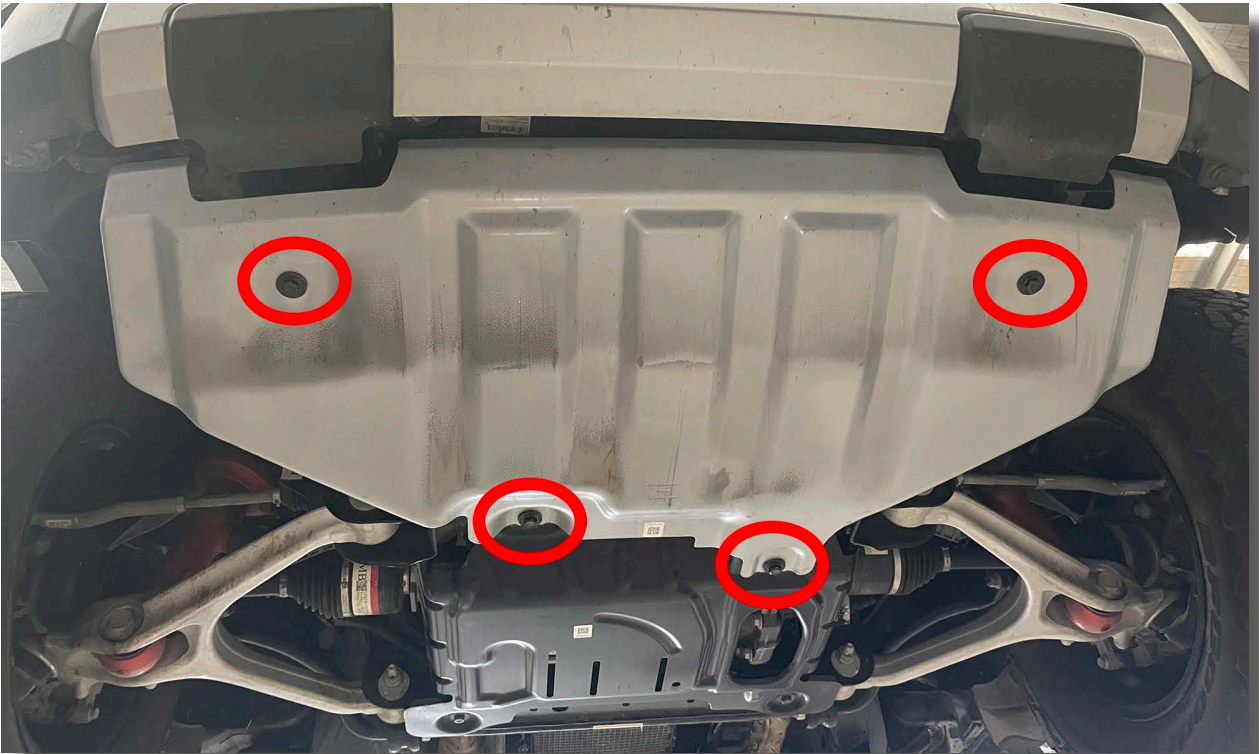



- 1.11. Remove the cooler from the packaging and place on a flat bench. Connect the 500mm joining hose to the bottom barb of the front cooler and the other to the top barb of the rear cooler. Secure with hose clamps supplied.

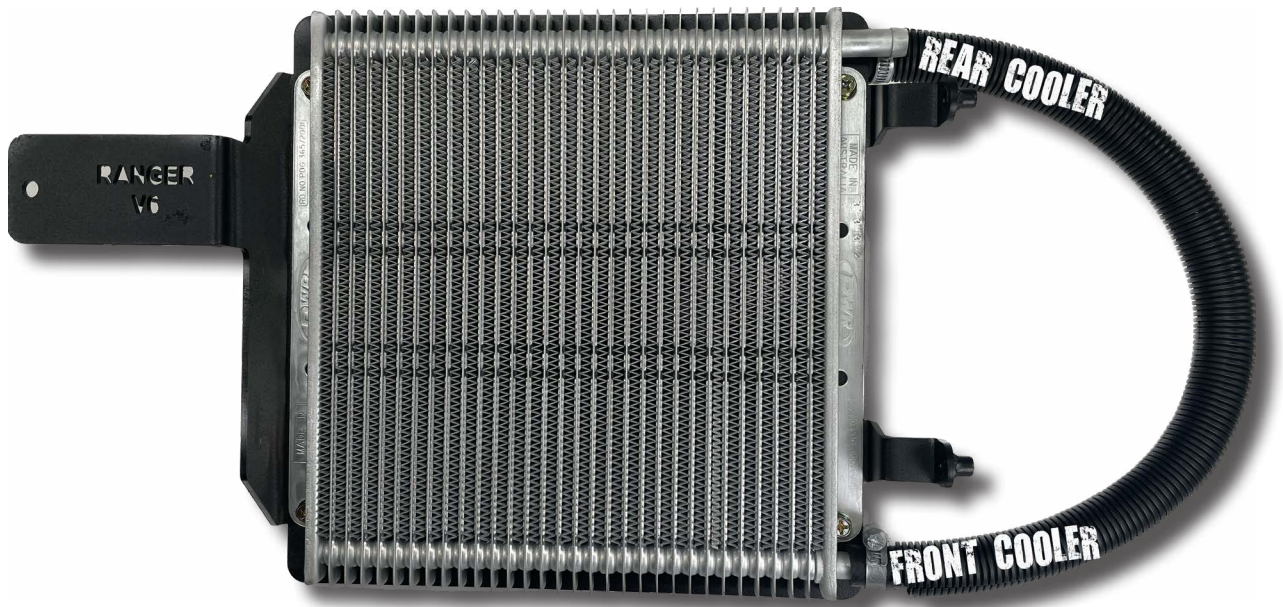

Coolers are omni-directional, so the direction of flow is not important. However for maximum efficiency and effectiveness we recommend the hot oil enters the rear cooler first.

- 1.12. Connect the 4m hose to the remaining barbs and secure with the hose clamps provided. Cut the 4m length of hose in half.

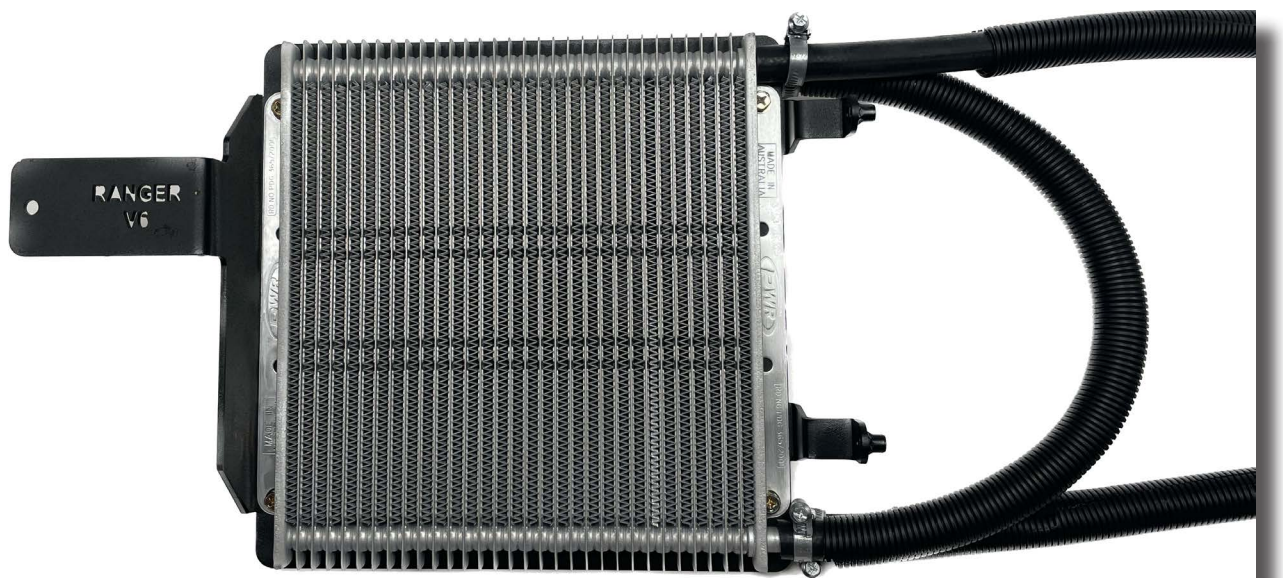

- 1.13. Position the cooler in the vehicle with the hoses running behind the center support towards the passenger side.

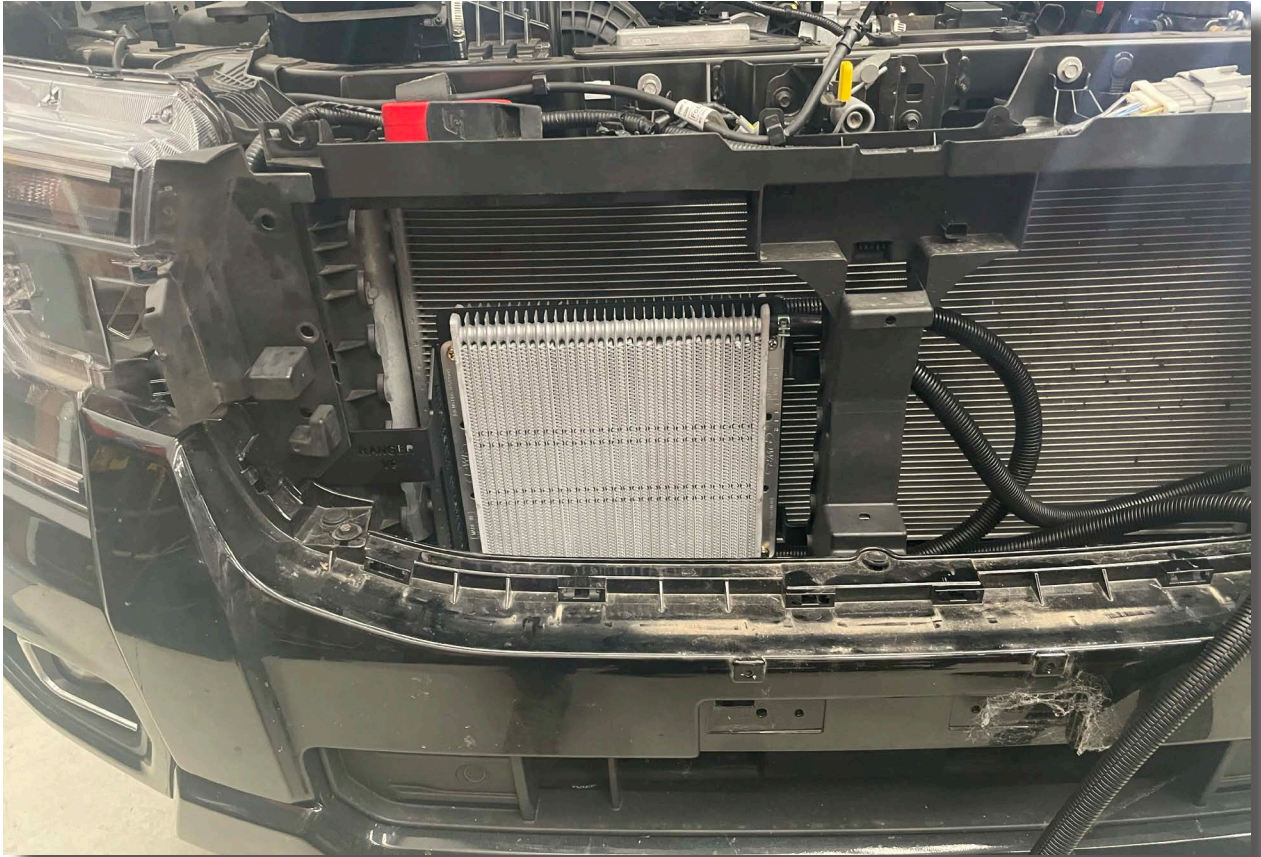

- 1.14. Using the M6 X 25 SEMS bolts supplied, mount the passenger side cooler bracket as shown below:

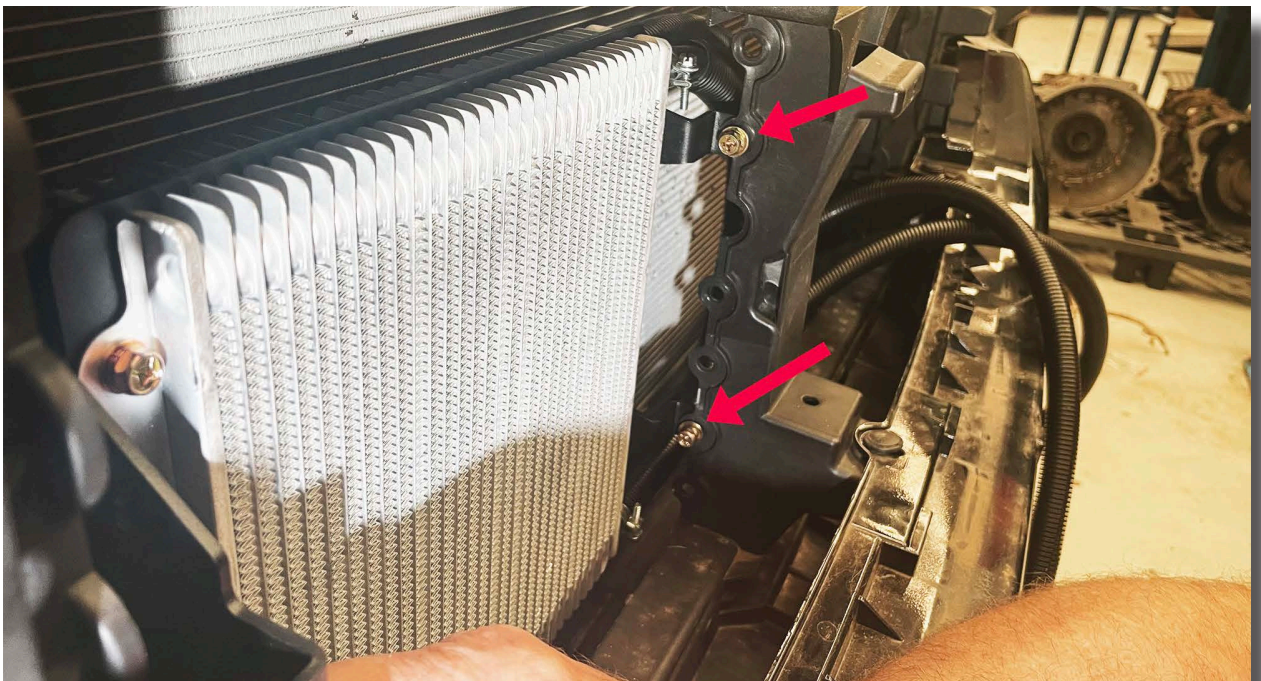

- 1.15. Use remaining M6 bolt and the tab with the Nutsert to secure the drivers side mount to the vehicle. Bracket should sit between the plastic guard and the support beam.

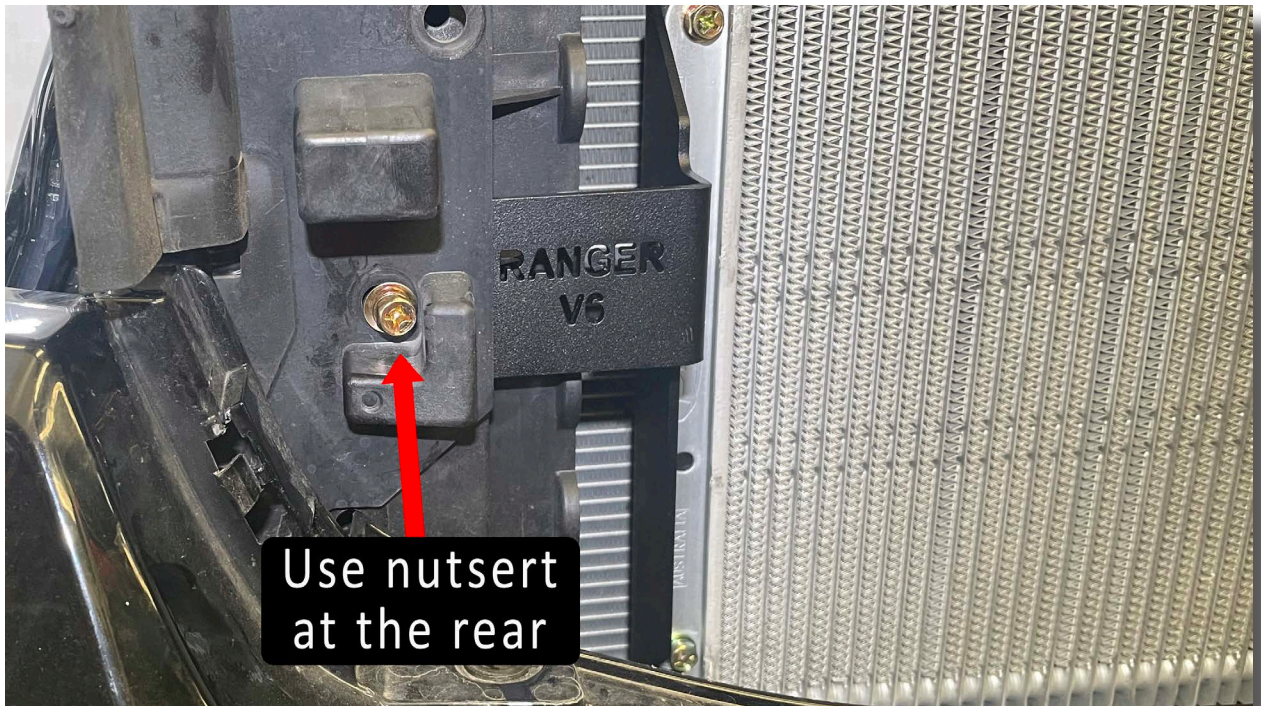

- 1.16. Feed the two cooler hoses under the air conditioning condenser.

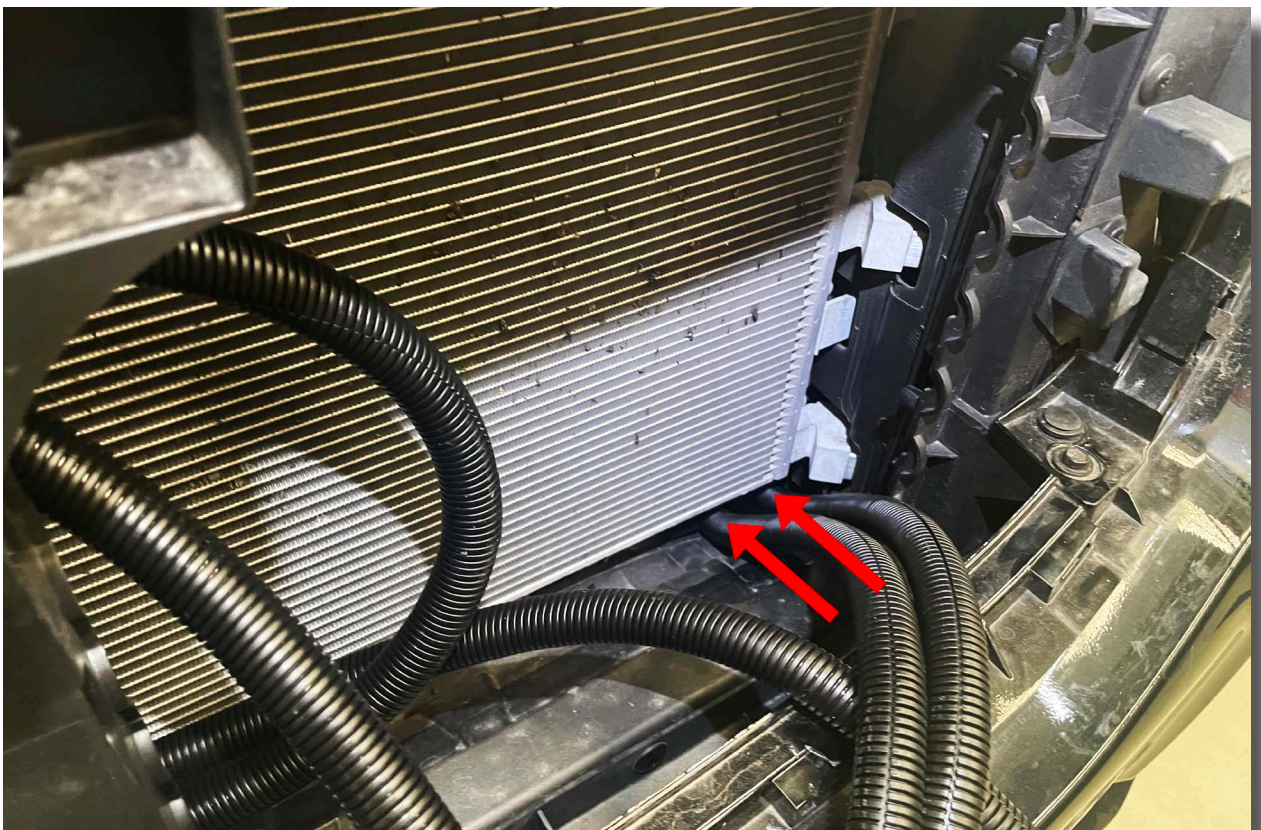

- 1.17. From under the car, run the hoses along the chassis rail and through to the transmission.

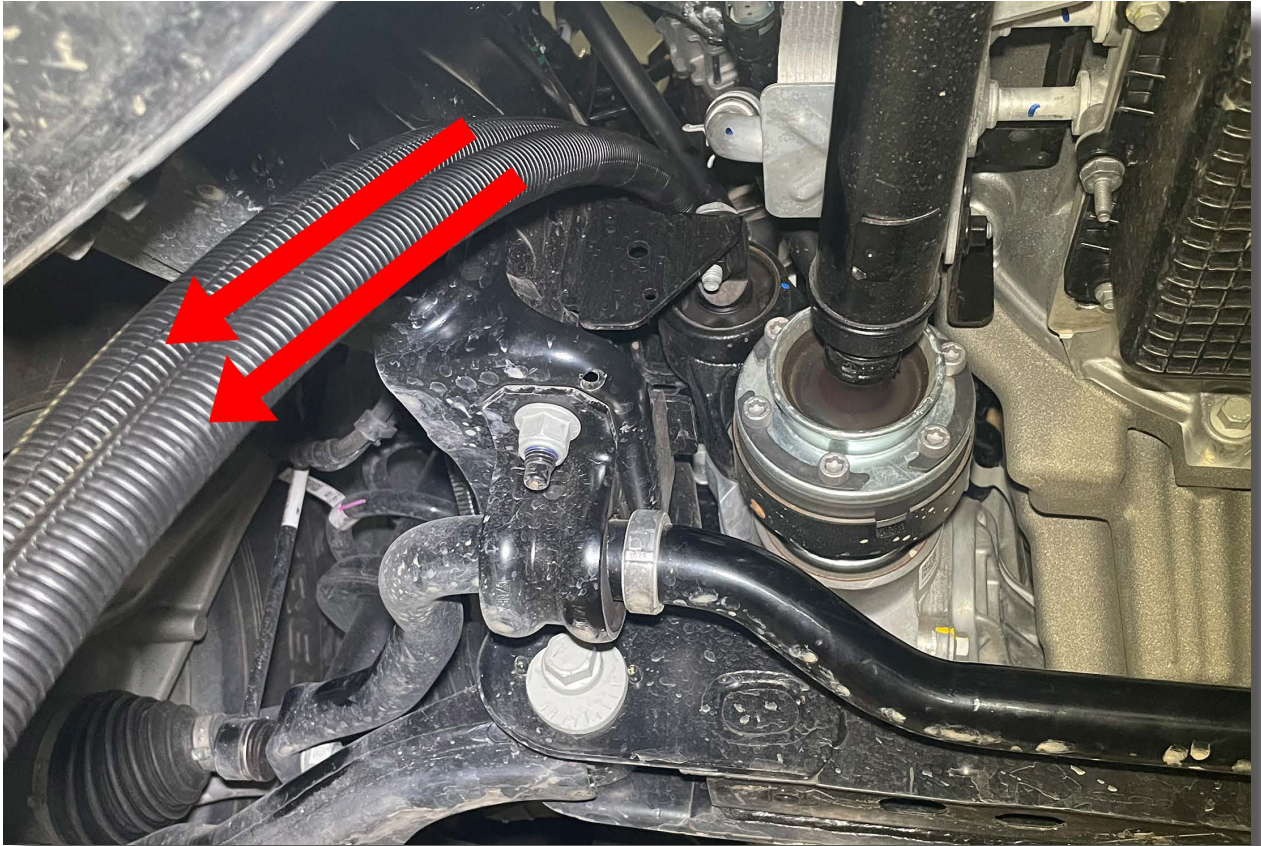

- 1.18. Check to ensure you have not put excess strain on the cooler and the hoses are free of kinks that may restrict flow. Hoses can be cable tied to each other to prevent movement.

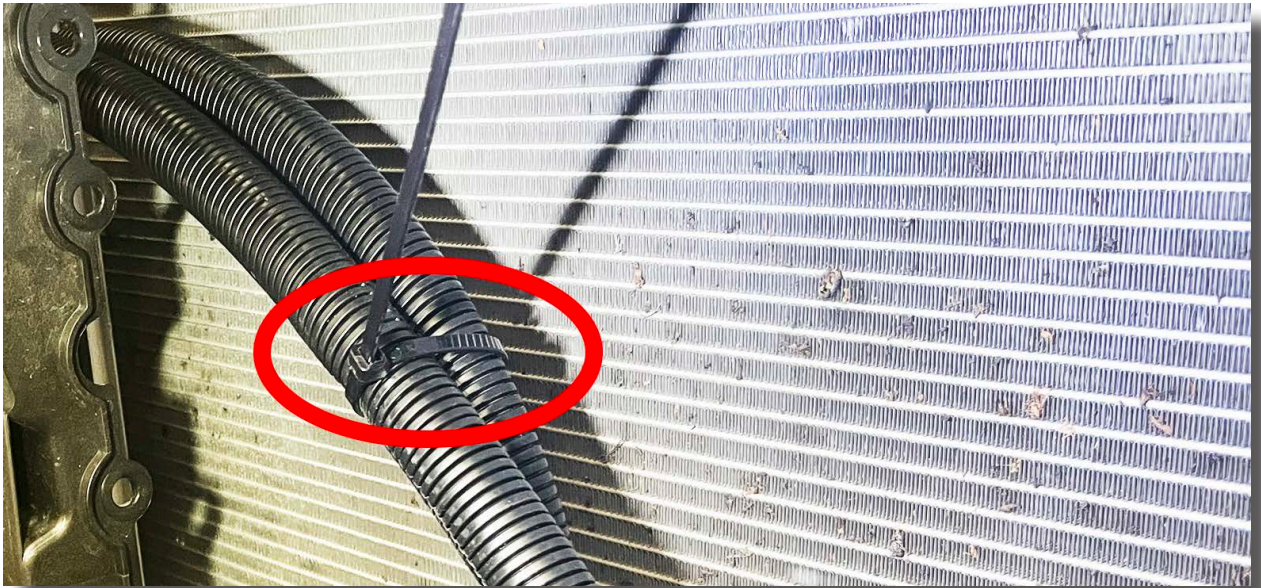

- 1.19. Locate the Heat Exchanger on the side of the transmission. The Heat Exchanger is redundant and will be removed, however you must first clamp the hoses to reduce fluid loss.

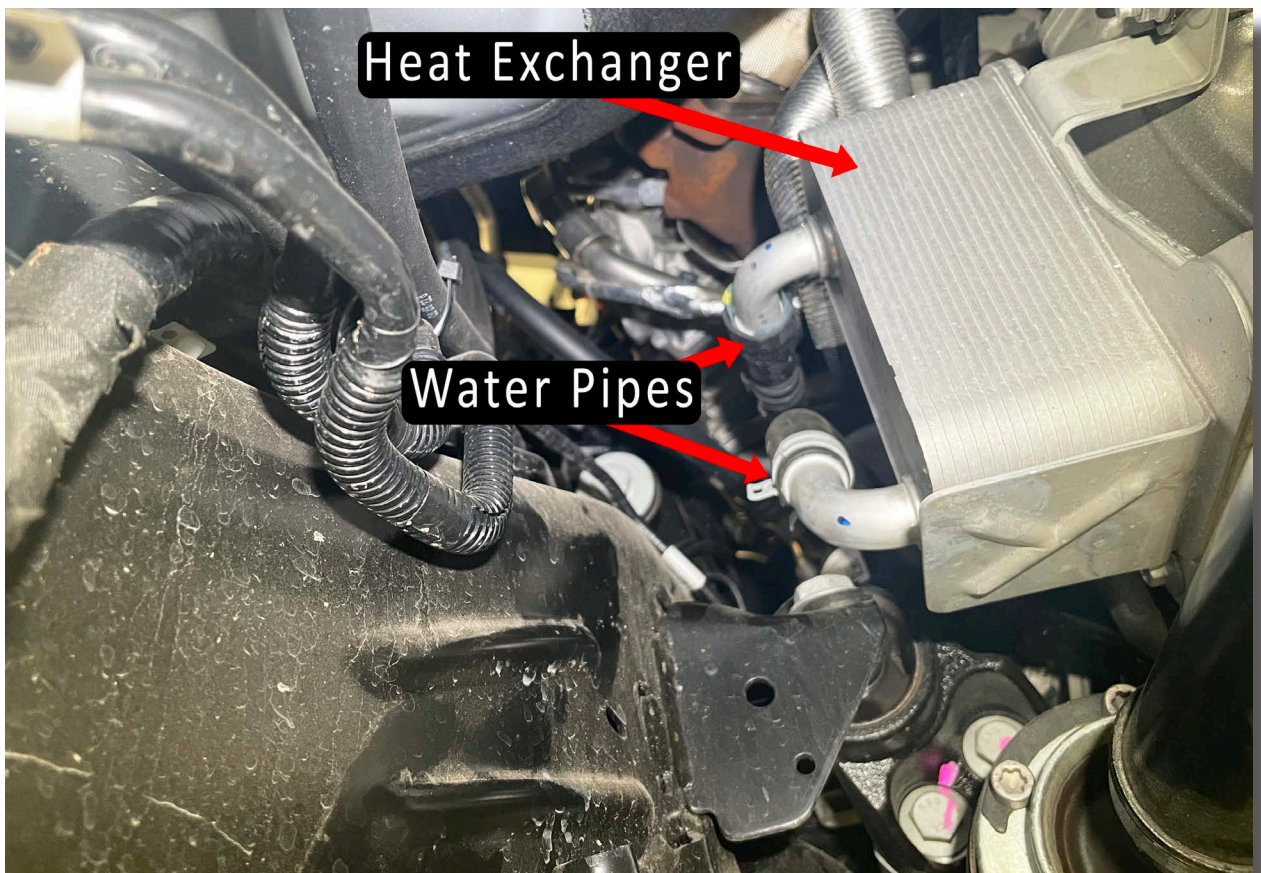

- 1.20. For easy access to clamp the hoses, remove the small plastic panel inside the passenger side wheel arch. There are four trim clips to be removed.

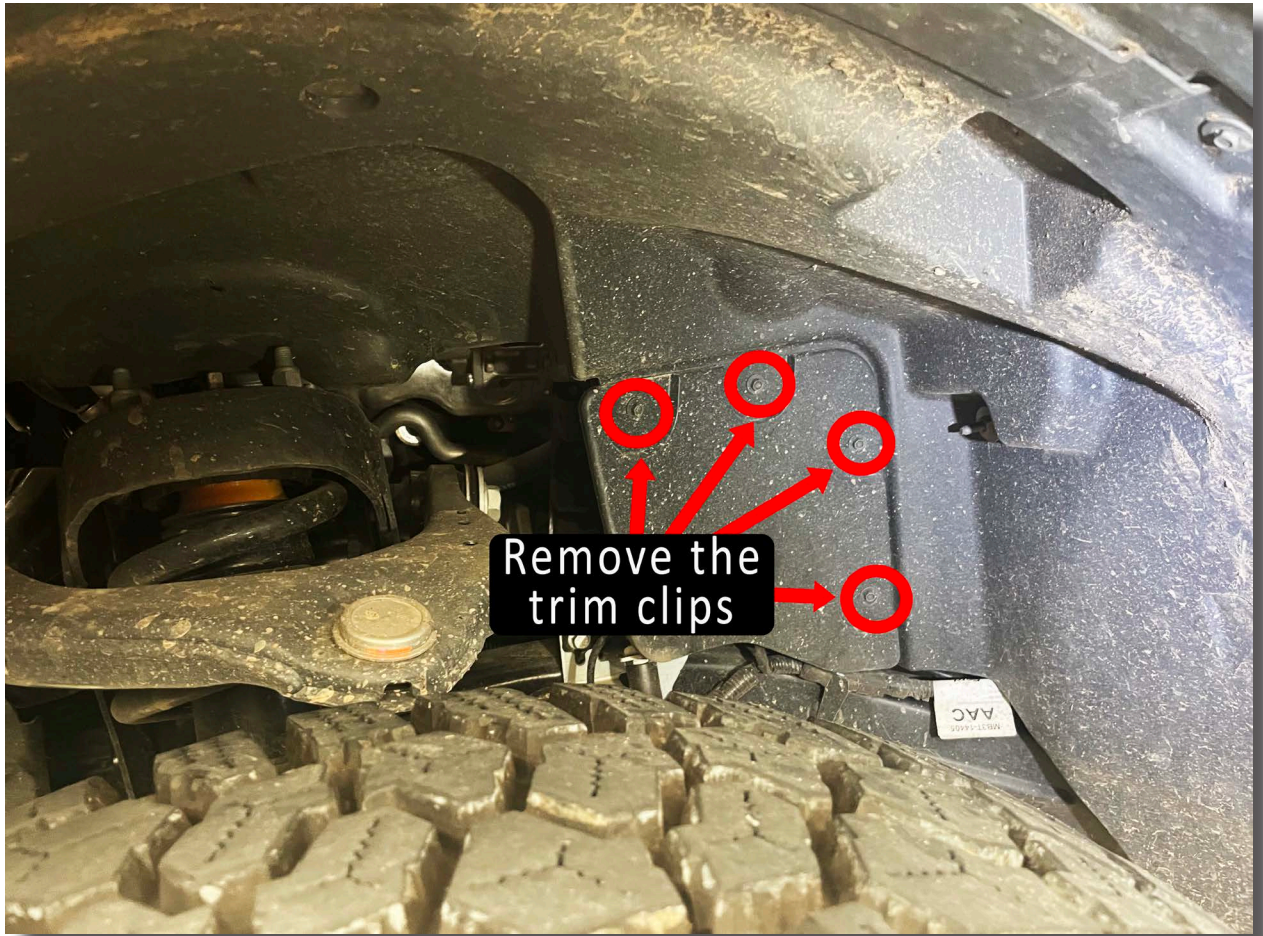

- 1.21. Use clamps to restrict the flow of coolant through the 2 hoses to be disconnected from the heat exchanger. Note: you may need to clamp the hoses in multiple places beyond the 'T' piece. We had 3 clamps in place past the 'T' piece before disconnecting the water pipes. **If you don't have clamps, the cooling system must now be drained; refill and bleed the cooling system after completing the install. Ensure you have sufficient coolant to re-fill the coolant system.**

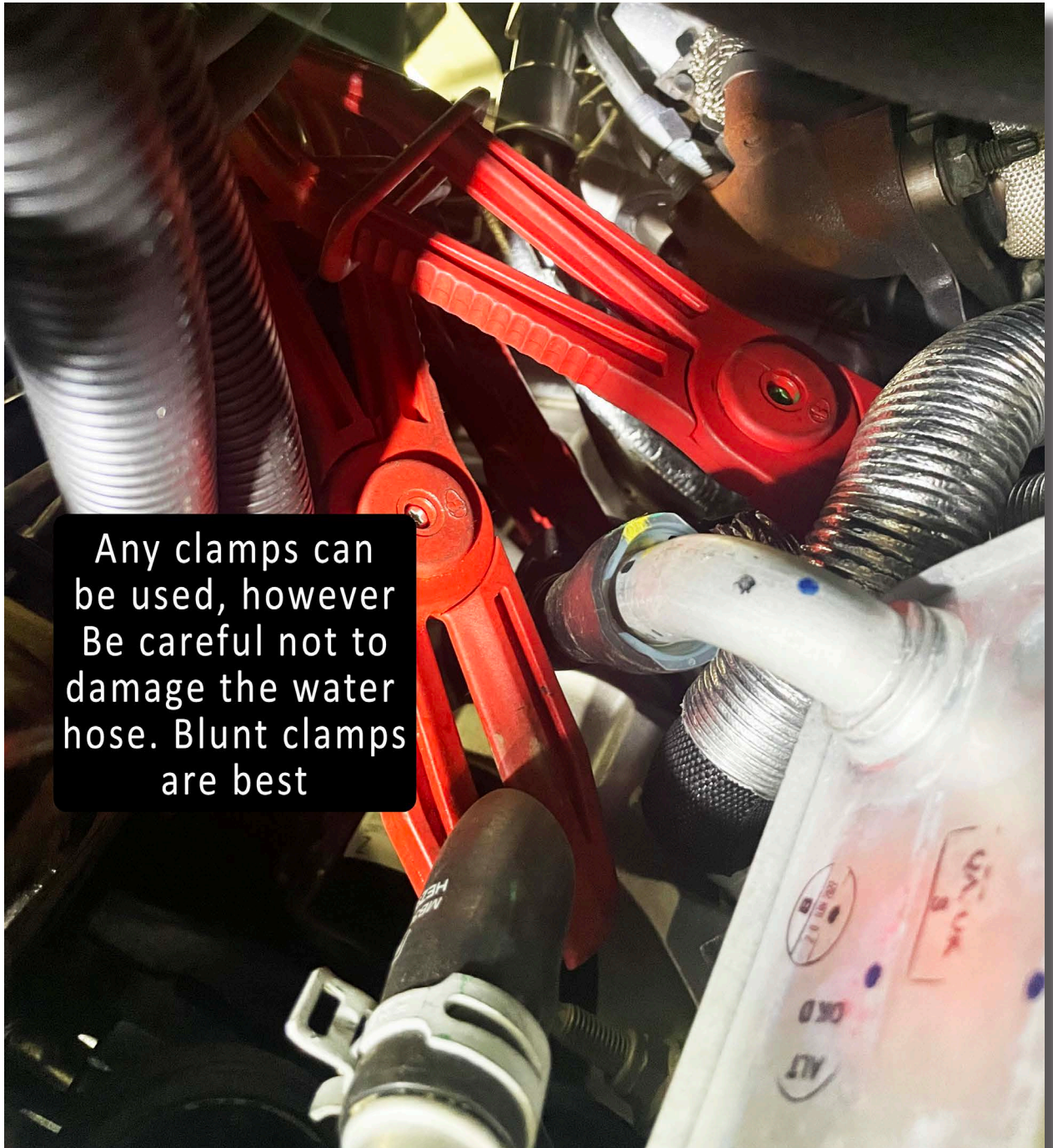

- 1.22. Carefully remove the water pipes by squeezing the plastic clips. Be careful to not damage the plastic clip in the 'T' piece, which will be reused to connect this hose to the 'L' pipe supplied. You may need to unbolt the heat exchanger to disconnect the 'T' piece.

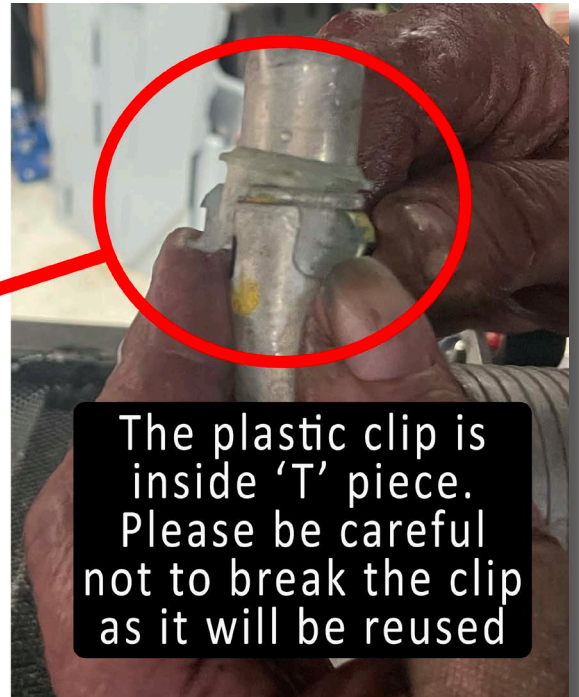
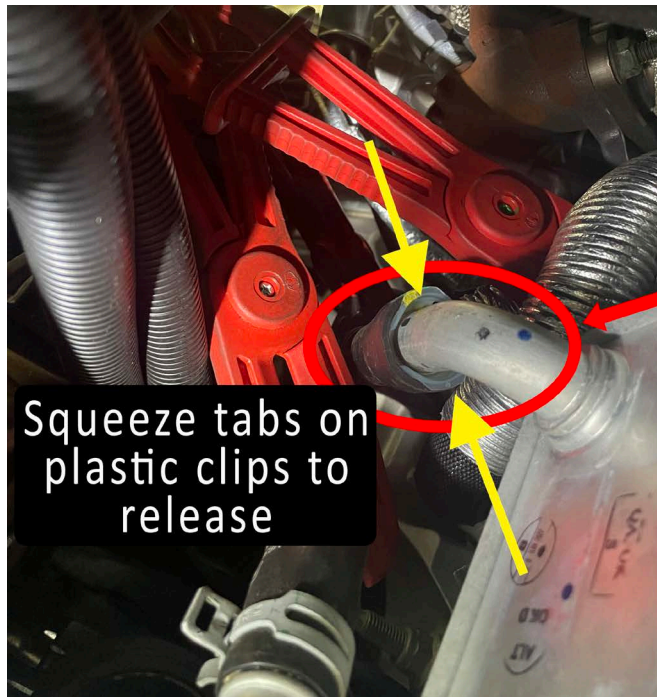

- 1.23. Unbolt the heat exchanger and remove from the transmission by pulling the oil pipes out of the transmission housing. Note that there will be some transmission fluid loss. There are 3 bolts holding it in place, including beneath the gear shift cable bracket.

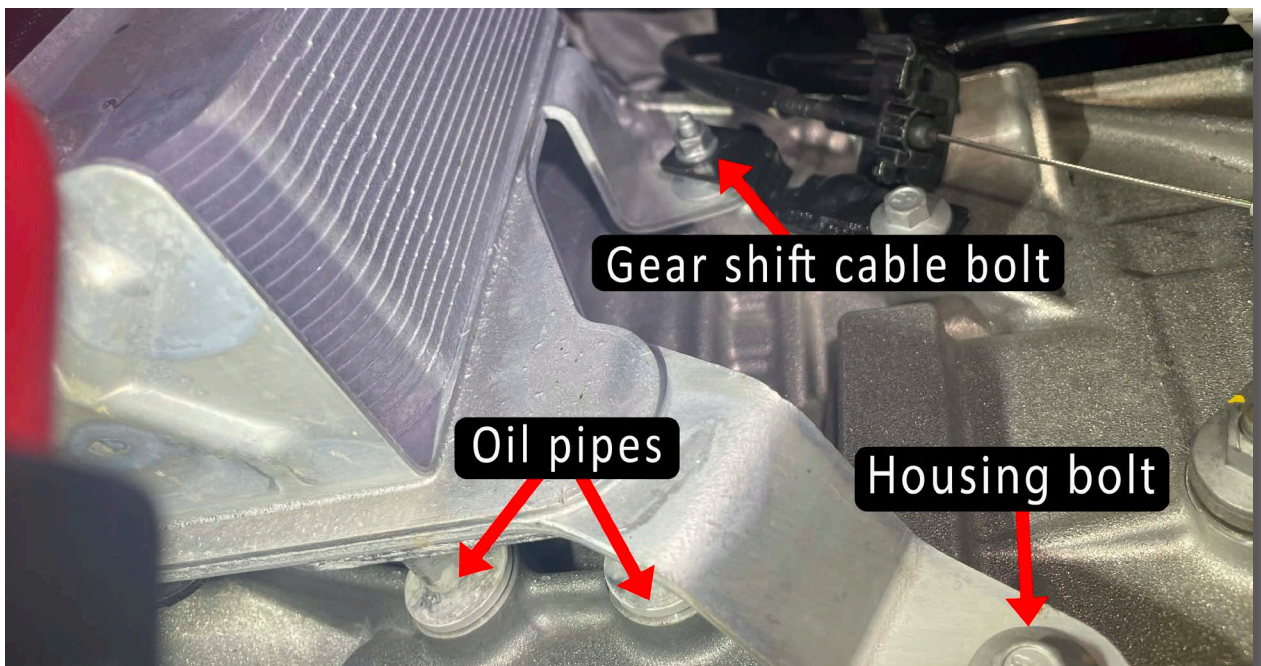



- 1.24. The heat exchanger bracket can also be removed and discarded, however, retain and replace the bolts.

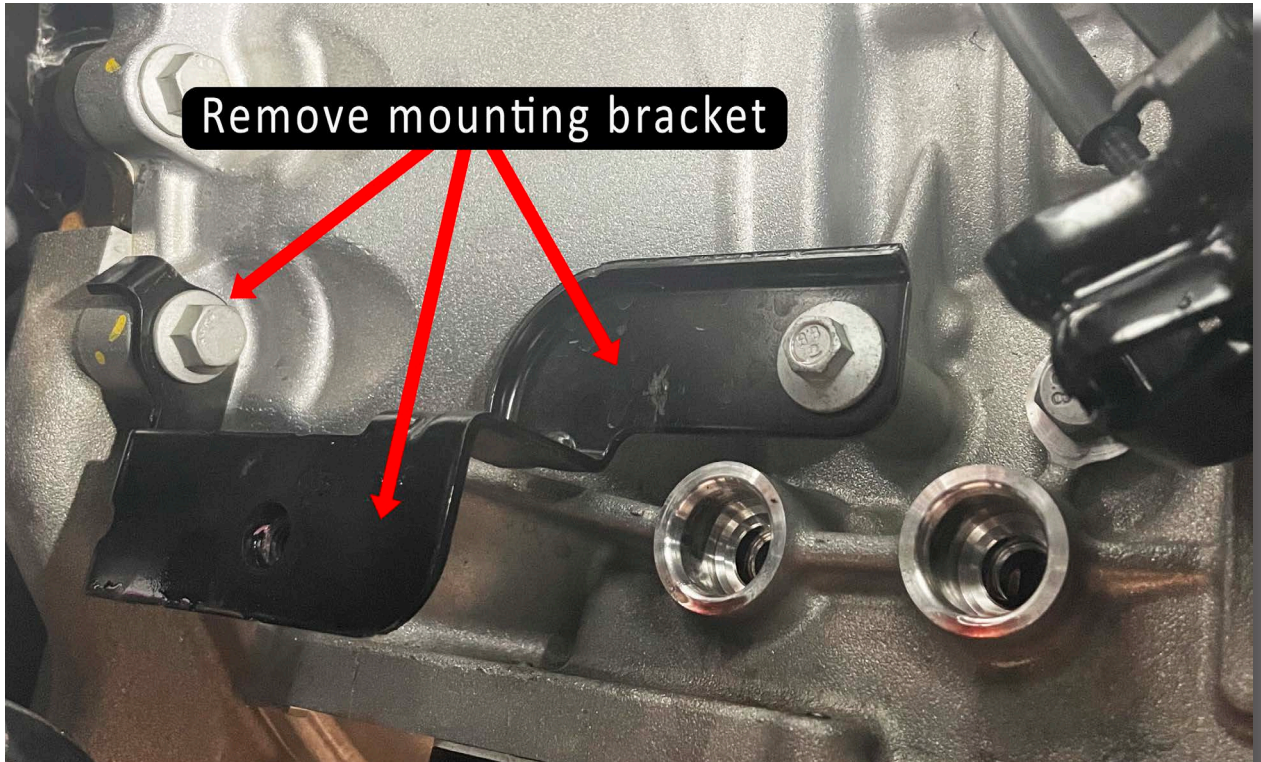

- 1.25. Reconnect the gear shift cable bracket using the two (2) M10 washers as spacers where the heat exchange bracket was removed.



- 1.26. Connect the 'L' pipe longer end to the 'T' piece with the plastic clip and the short end to the other hose to create a heat exchange by-pass. Secure using one 14-27mm hose clamps supplied, and the factory plastic clip. Ensure the twisted hose does not restrict flow.



- 1.27. Install the supplied custom cooler unions. Check that each union has two (2) o-rings fitted prior to installation, and apply a small amount of transmission fluid to both o-rings on both unions to provide lubrication. Install the unions by carefully inserting them into the empty fittings in the side of the transmission left behind by the removal of the heat exchanger. Secure the new unions with the supplied bracket, using one of the T40 Torx bolts previously removed from the heat exchanger.

\*Note\*: if installing with a temperature gauge the union to use for the temperature sensor is the rear union. This is the hot fluid output from the transmission.

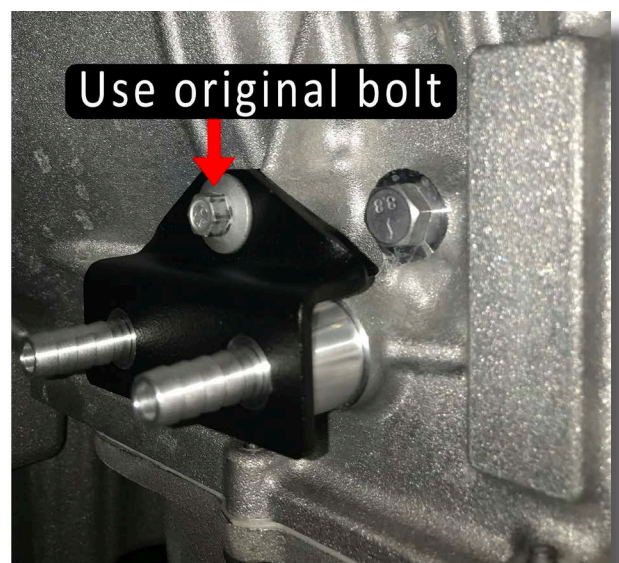
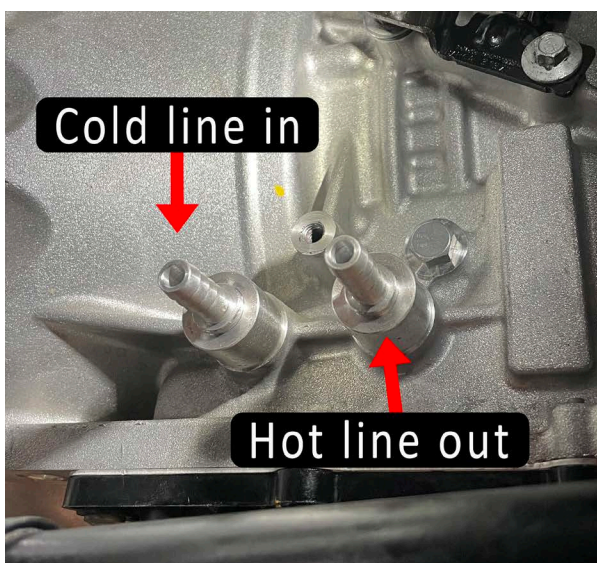

- 1.28. Route cooler lines to the unions and trim to the correct length. Secure using the hose clamps provided. For the best cooling performance we recommend the hottest oil (from the rear union) goes through the rear cooler first. Ensure that hoses are secure away from moving parts with no kinks that may impede flow.

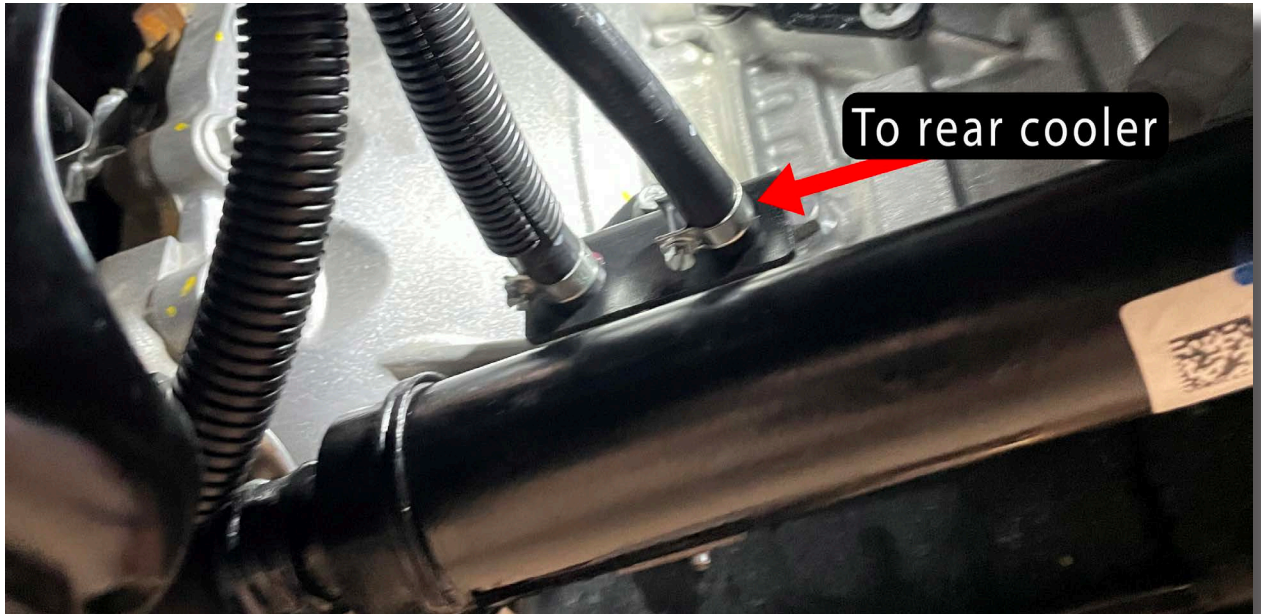

- 1.29. Secure using cable ties provided. Remove all clamps and replace the plastic panel that was removed from the wheel arch and refit bash plate.

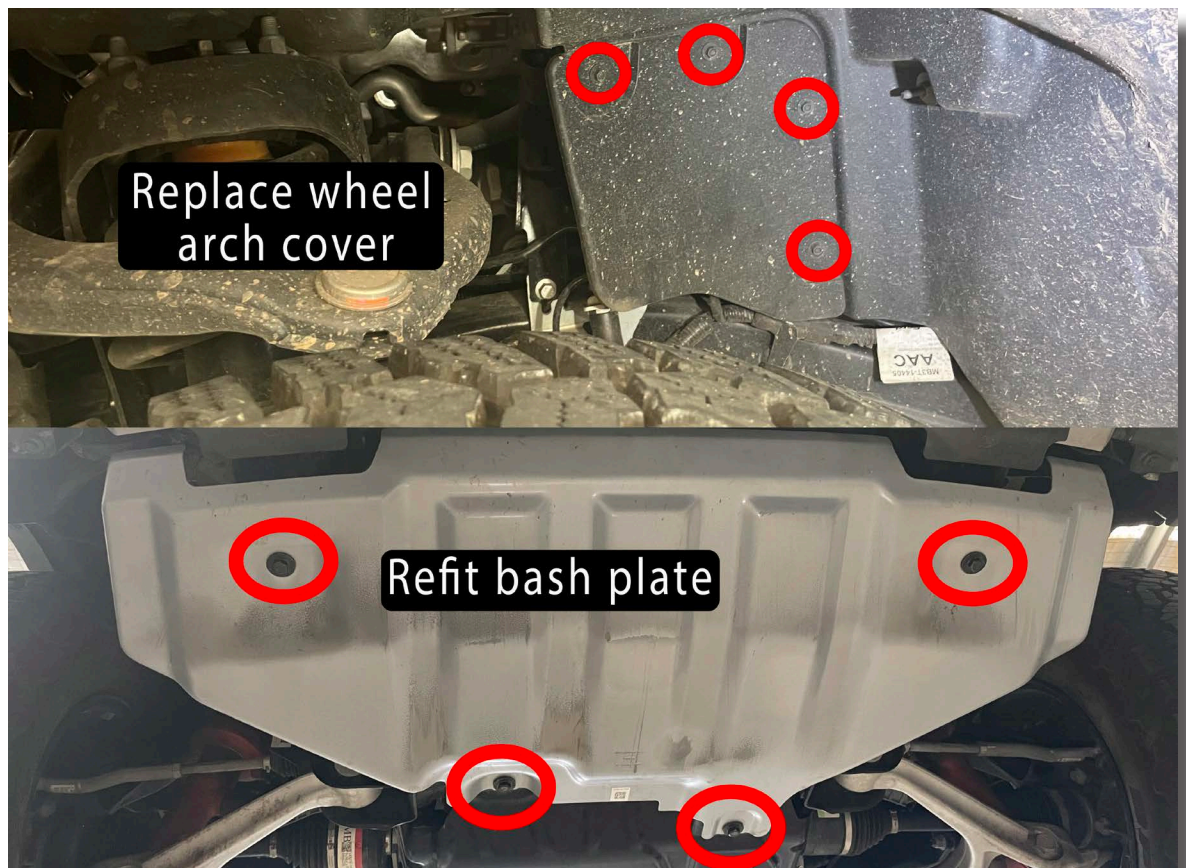

1.30. Replace the front grill and bolt in place.



1.31. Reconnect the 2 plugs above the grill for the front facing camera and washer.  
Don't forget to top up the washer bottle!



1.32. Reinstall the number plate holder and number plate.



1.33. Reinstall the top cover using the 13 clips previously removed and secure the air inlet using the T30 Torx bit.

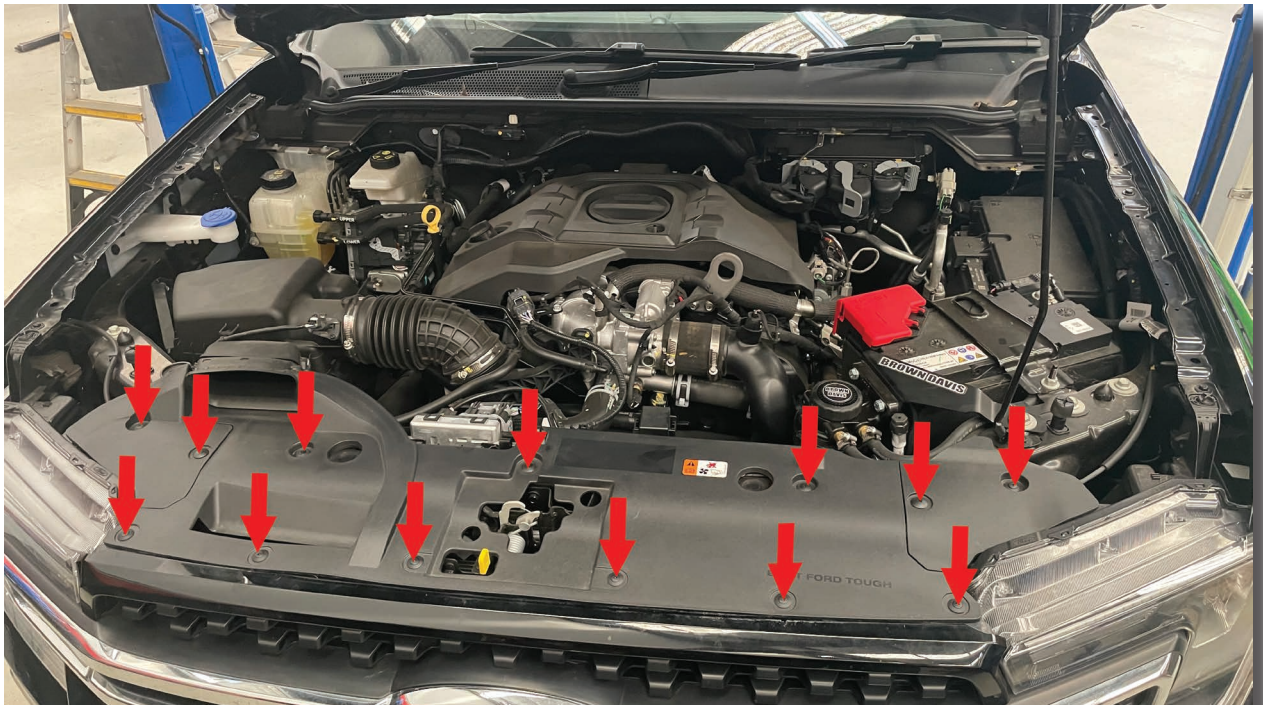

- 1.34. Check the coolant level. If the engine cooling system was drained while removing the heat exchanger now is the time to re-fill the cooling system with coolant that meets or exceeds the genuine coolant specification. If you were able to clamp the lines the cooling system should only require a small top up.
- 1.35. Before test driving the vehicle ensure you check the transmission fluid level and if necessary, top up with Genuine Transmission Fluid or any full synthetic transmission fluid that meets or exceeds the genuine oil specification.
- 1.36. Road test vehicle for a minimum of 15 minutes. Try to find a couple of hills that will get the transmission to work hard.
- 1.37. Check the transmission coolers, fittings, hoses, unions, mountings and clamps for any leaking or loose fittings. Tighten if necessary.
- 1.38. Check engine coolant level and transmission fluid level again. See the following pages for the correct fluid level.

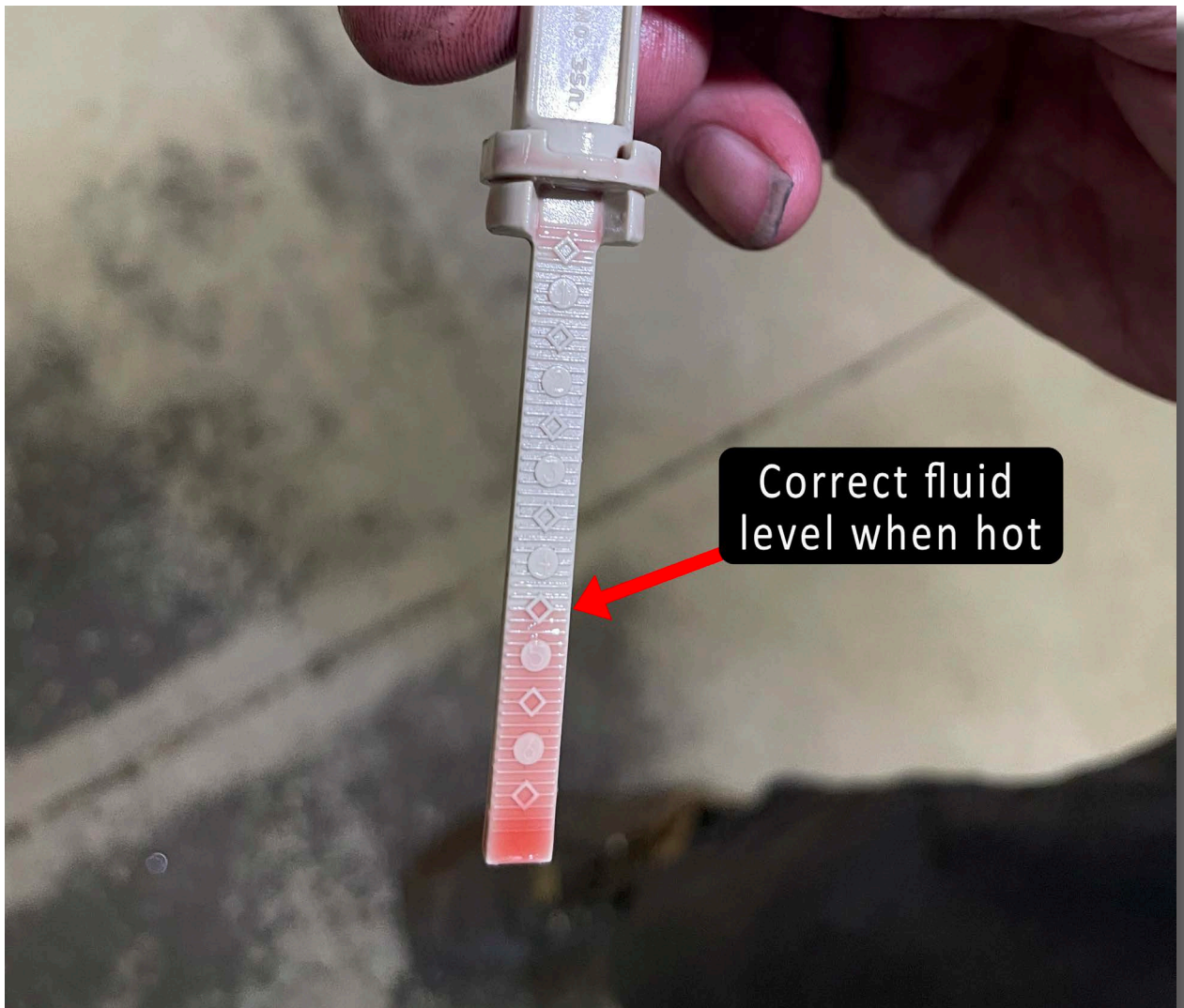

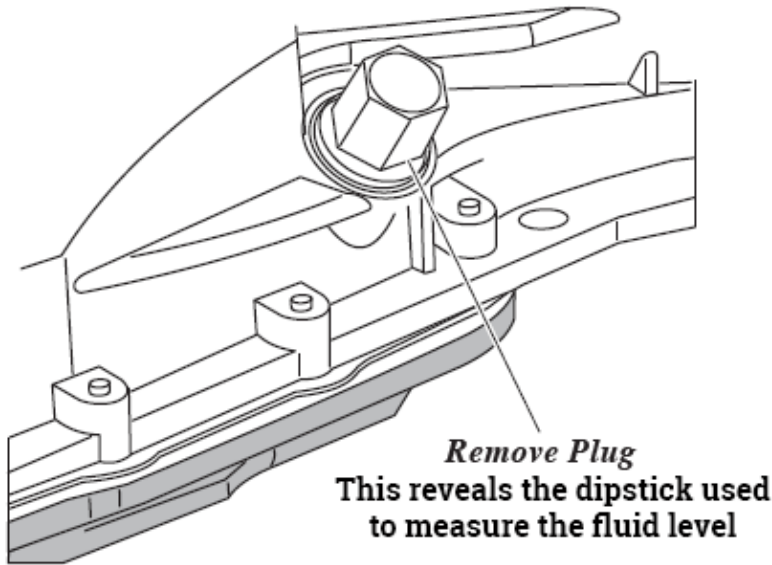
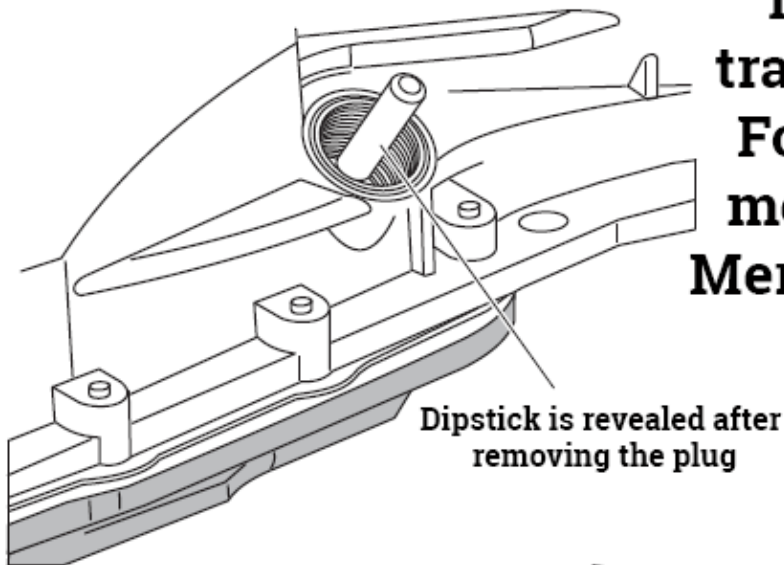
***FLUID FILL PLUG******FLUID LEVEL INDICATOR***

**The recommended transmission fluid for Ford 10R80 10 Speed meets or exceeds the Mercon ULV<sup>®</sup> standard.**

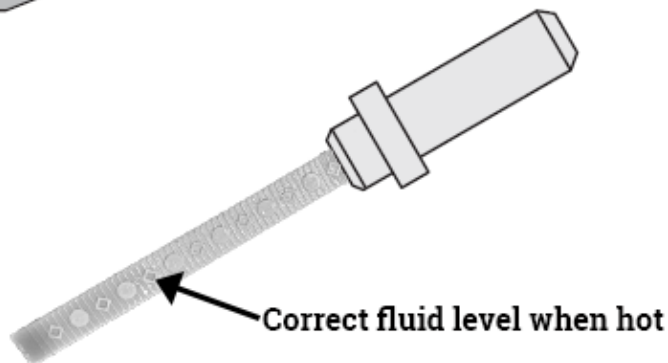

*Check fluid level hot idle in park*

This completes the installation of the Dual  
Transmission Oil Cooler Kit to suit:

Ford Ranger Next-Gen, Ford Everest UB or VW  
Amarok NF, with 3.0L V6 Turbo Diesel and 10  
Speed Automatic Transmission.

Please remember ALL automatic transmissions  
have a service interval of 2 years or 40,000km to  
improve the longevity of the transmission.

Please Provide us with Feedback

If you have a minute to provide us with some feedback about your experience with Wholesale Automatic  
Transmissions and our products, that would be greatly appreciated.

Using your smart phone or device's camera app, point at the QR code below to take you straight to our  
feedback page for you to choose the most appropriate feedback method.

